



# evolution wireless G4 300 series / 500 series

Instruction Manual



## Accessories

A variety of accessories are available for the ew 300-500 G4 series.

### Microphones and cables

#### Microphone modules

We recommend using the following microphone modules with the SKM 300 G4 and SKM 500 G4 handheld transmitters.

Module	Features	Article no.
<b>MMD 835-1 BK</b>	Dynamic, cardioid, black	502575
<b>MMD 845-1 BK</b>	Dynamic, super-cardioid, black	502576
<b>MME 865-1 BK</b>	Capacitor, super-cardioid, black	502581
<b>MMD 935-1 BK</b>	Dynamic, cardioid, black	502577
<b>MMD 945-1 BK</b>	Dynamic, super-cardioid, black	502579
<b>MMK 965-1 BK</b>	Capacitor, switchable Cardioid/super-cardioid, black	502582
<b>MMK 965-1 NI</b>	Capacitor, switchable Cardioid/super-cardioid, nickel	502584
<b>MD 9235 BK</b>	Dynamic, cardioid, black	502585
<b>MD 9235 NI</b>	Dynamic, cardioid, black	502586
<b>MD 9235 NI/BK</b>	Dynamic, cardioid, nickel/black	502591
<b>Neumann KK 204</b>	Capacitor, cardioid, nickel	008651
<b>Neumann KK 204 BK</b>	Capacitor, cardioid, black	008652
<b>Neumann KK 205</b>	Capacitor, super-cardioid, nickel	008653
<b>Neumann KK 205 BK</b>	Capacitor, super-cardioid, black	008654

**i** You can find more information about the individual microphone modules on their respective product pages at [www.sennheiser.com](http://www.sennheiser.com).



### Headset and Lavalier microphones

We recommend using the following Lavalier microphones and headset microphones with the SK 300 G4 and SK 500 G4 bodypack transmitters.

Microphone	Features	Article no.
<b>ME 2-II</b>	Lavalier microphone, omni-directional, black	507437
<b>ME 3-II</b>	Headset microphone, cardioid, black	506295
<b>ME 4-N</b>	Lavalier microphone, cardioid, black	005020
<b>MKE 1-ew</b>	Lavalier microphone, omni-directional, black	502876
<b>MKE 1-ew-3</b>	Lavalier microphone, omni-directional, beige	502879
<b>MKE 2-ew Gold</b>	Lavalier microphone, omni-directional, black	009831
<b>MKE 2 ew-3 Gold</b>	Lavalier microphone, omni-directional, beige	009832
<b>MKE 40-ew</b>	Lavalier microphone, cardioid, black	500527
<b>SL Headmic 1 BE</b>	Headband microphone, omni-directional, beige	506272
<b>SL Headmic 1 BK</b>	Headband microphone, omni-directional, black	506271
<b>SL Headmic 1 SB</b>	Headband microphone, omni-directional, silver	506904

**i** You can find more information about the individual microphones on their respective product pages at [www.sennheiser.com](http://www.sennheiser.com).

### Line/instrument cables

The following cables are available to connect instruments and line sources to the SK 300 G4 and SK 500 G4 bodypack transmitters:

- **Sennheiser CL 2**  
Line cable with XLR-3F plug on lockable 3.5 mm jack plug, article no. 004840
- **Sennheiser Ci 1-N**  
Guitar cable with 6.3 mm jack plug on lockable 3.5 mm jack plug, article no. 005021



## Rechargeable battery and charger

### BA 2015 rechargeable battery

The BA 2015 rechargeable battery is designed for use with evolution wireless G4 series handheld transmitters, bodypack transmitters and bodypack receivers.

Article no. 009950



### L 2015 charger

The BA 2015 rechargeable battery can be charged in the L 2015 charger on its own or inside of the bodypack transmitter/bodypack receiver.

Article no. 009828





### LA 2 charging adapter

Charging adapter for L 2015 charger for charging SKM G4 handheld transmitters with installed BA 2015 rechargeable battery.

Article no. 503162





## Accessories for rack mounting

### GA 3 rack mount kit

19" rack adapter for mounting the EM 100 G4, EM 300 G4, EM 500 G4 or SR 300 IEM G4 in a 19" rack.

Article no. 503167



### AM 2 antenna front mounting kit

Antenna front mounting kit for installing antenna connections on the front of the rack when using the EM 100 G4, EM 300 G4, EM 500 G4 or SR 300 IEM G4 together with the GA 3 rack mounting kit.

Article no. 009912





## Antennas and accessories

The following antenna components are available as accessory parts.

### Omni-directional antennas

- **A 1031-U**, passive omni-directional antenna, article no. 004645

### Directional antennas

- **A 2003 UHF**, passive directional antenna, article no. 003658

### Antenna splitter

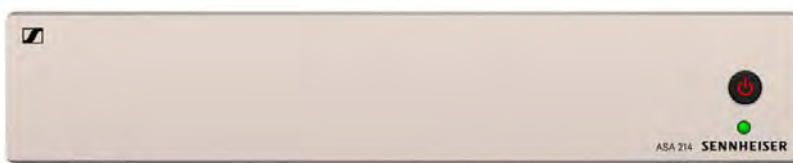

- **ASA 214**, active antenna splitter 2×1:4
  - **ASA 214-UHF** variant, 470 – 870 MHz, article no. 508241

### Antenna amplifiers

- **AB 3700**, broadband antenna amplifier, article no. 502196
- **AB 4**, antenna amplifier, up to 88 MHz bandwidth  
Available from the end of 2018



## Additional accessories

### Color labeling set

- **KEN 2**, color labeling set for SKM handheld transmitters, article no. 530195



### Microphone clamp

- **MZQ 1**, microphone clamp for SKM handheld transmitters, article no. 076670



### MUTE switch

- **RMS 1**, remote mute switch for SK 300 G4, article no. 503164







## The frequency bank system

There are different frequency ranges in the UHF band available for transmission.

The following frequency ranges are available for the **ew 300-500 G4** series:

- **Aw+ range:** 470 – 558 MHz
- **AS range:** 520 – 558 MHz
- **Gw1 range:** 558 – 608 MHz
- **Gw range:** 558 – 626 MHz
- **GBw range:** 606 – 678 MHz
- **Bw range:** 526 – 698 MHz
- **Cw range:** 718 – 790 MHz
- **Dw range:** 790 – 865 MHz
- **JB range:** 806 – 810 MHz
- **K+ range:** 925 – 937.5 MHz

Every frequency range has **26 frequency banks** with up to 32 channels:

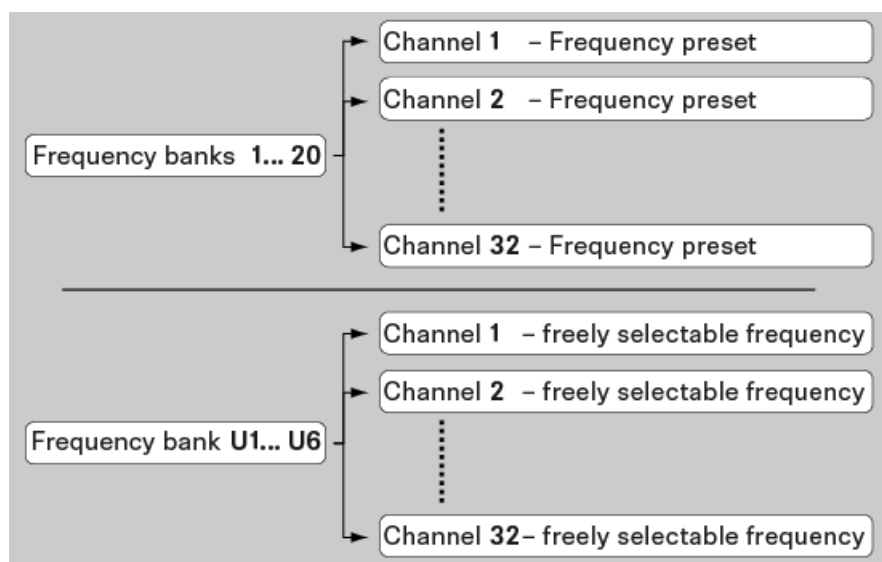

---

**i** You can find information about the frequency presets in the frequency tables of the respective frequency ranges under “Frequency tables”.

---



## Installing the EM 300-500 G4

These sections contain detailed information about installing and starting up the EM 300-500 G4.

You can find information about operating the EM 300-500 G4 under “Using the EM 300-500 G4”.

### Connectors on the rear of the device

#### Product overview for the rear of the EM 300-500 G4

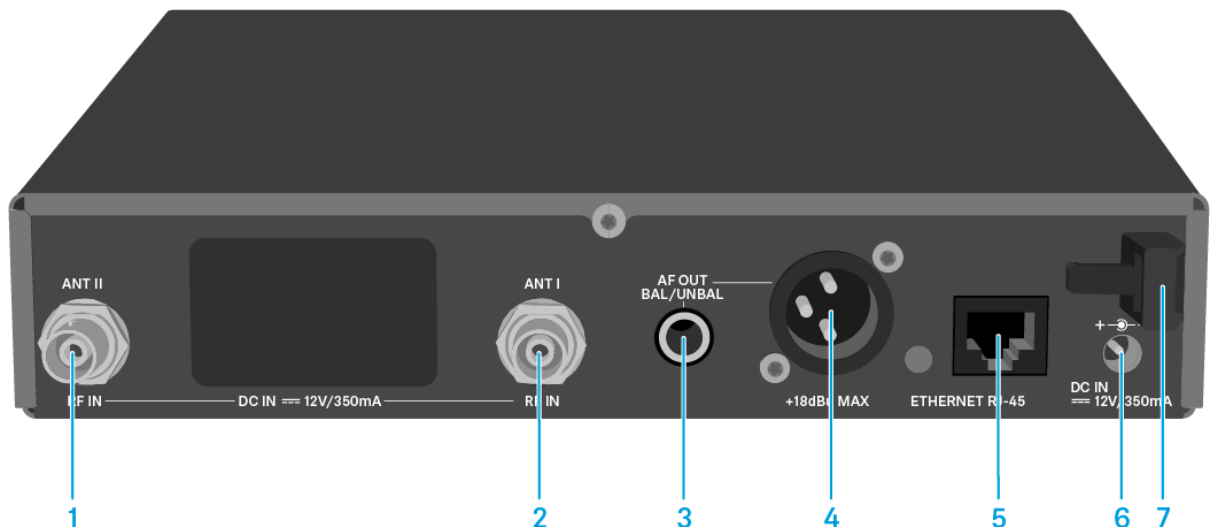

- 1 BNC socket, antenna input II (**ANT II**) with remote power supply unit
  - See “Connecting antennas”
- 2 BNC socket, antenna input I (**ANT I**) with remote power supply unit
  - See “Connecting antennas”
- 3 6.3 mm jack socket for audio output, unbalanced (**AF OUT UNBAL**)
  - See “Outputting audio signals”
- 4 XLR-3 socket for audio output, balanced (**AF OUT BAL**)
  - See “Outputting audio signals”
- 5 LAN connection socket (**ETHERNET RJ 45**)
  - See “Creating a data network”
- 6 Connecting cables for the power supply unit (**DC IN**)
  - See “Connecting/disconnecting the EM 300-500 G4 to/from the power supply system”
- 7 Strain relief for the cable of the power supply unit
  - See “Connecting/disconnecting the EM 300-500 G4 to/from the power supply system”



## Connecting/disconnecting the EM 300-500 G4 to/from the power supply system

Only use the supplied power supply unit. It is designed for your receiver and ensures safe operation.

To connect the EM 300-500 G4 to the power supply system:

- ▷ Insert the plug of the power supply unit into the **DC IN** socket of the receiver.
- ▷ Pass the cable of the power supply unit through the cable grip.
- ▷ Slide the supplied country adapter onto the power supply unit.
- ▷ Plug the power supply unit into the wall socket.

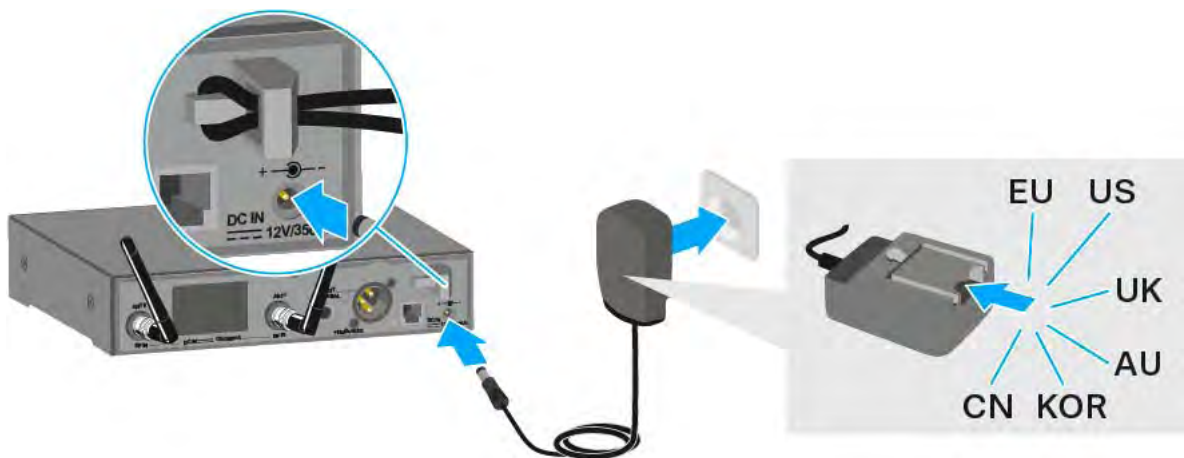

To completely disconnect the EM 300-500 G4 from the power supply system:

- ▷ Unplug the power supply unit from the wall socket.
- ▷ Unplug the power supply unit from the **DC IN** socket of the receiver.



## Creating a data network

You can monitor and control one or more EM 300-500 G4s via a network connection using **Sennheiser Wireless Systems Manager (WSM)** software.

**i** Automatic frequency setup can also be performed over the network without the WSM software. See “Easy Setup menu item”.

To connect the EM 300-500 G4 to a network:

- ▷ Connect a network cable with an RJ-45 connector (to the **Ethernet** socket on the rear side of the EM 300-500 G4).
- ▷ Connect the other end of the network cable to a network switch.

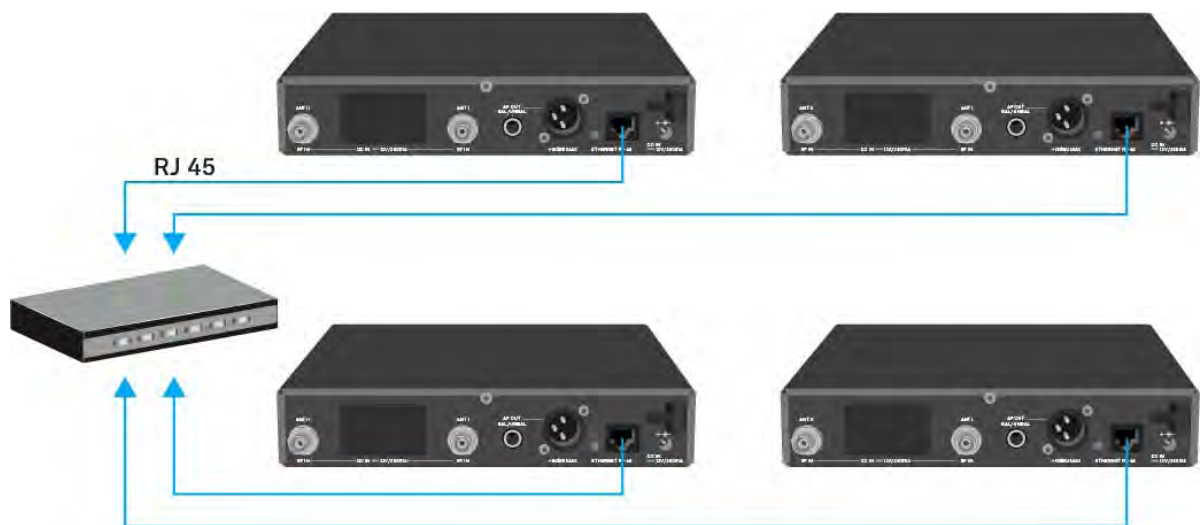

**i** For more information about controlling devices via the **Sennheiser Wireless Systems Manager (WSM)** software, refer to the instruction manual for the software. You can download the software here:

[www.sennheiser.com/wsm](http://www.sennheiser.com/wsm)



## Outputting audio signals

The EM 300-500 G4 has a balanced XLR-3M output socket and an unbalanced 6.3 mm jack output socket.

- Always use only one of the two **BAL AF OUT** output sockets for each channel.

To connect an XLR cable:

- Plug the XLR cable into the **AF OUT BAL** socket of the EM 300-500 G4.

To connect a jack cable:

- Plug the jack cable into the **AF OUT UNBAL** socket of the EM 300-500 G4.

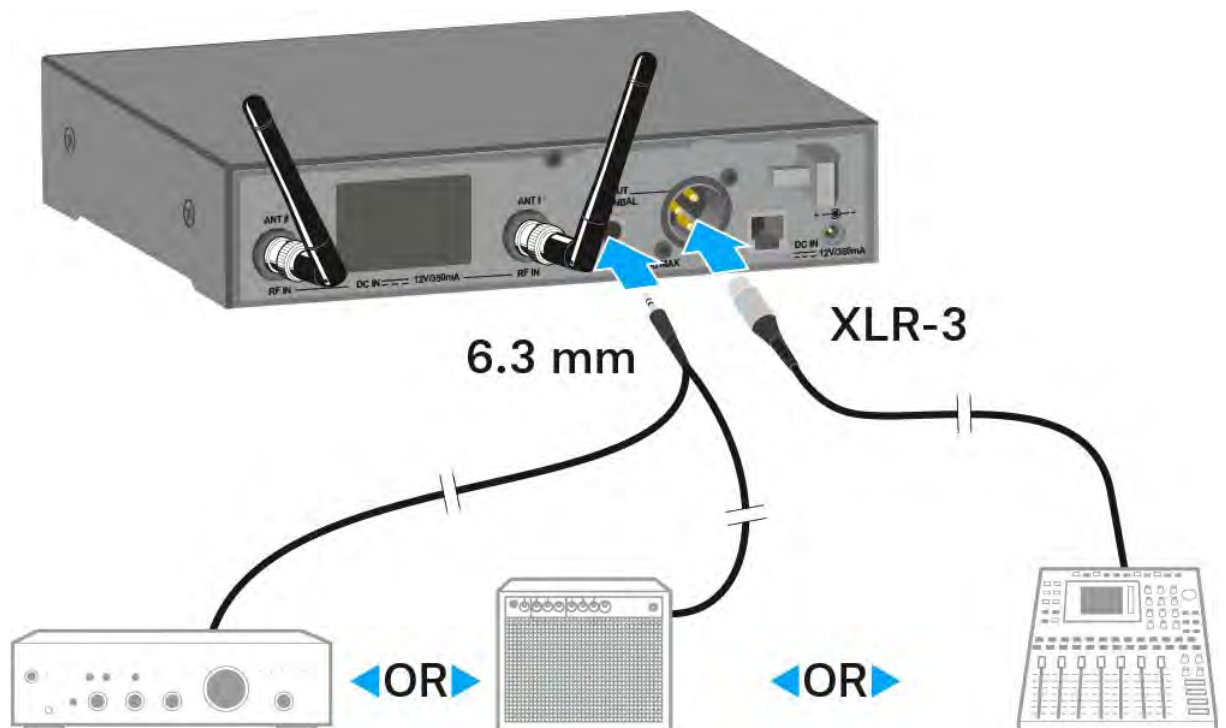



## Connecting antennas

To connect the supplied rod antennas:

- ▷ Connect the first rod antenna to the **ANT I** socket on the rear side of the EM 300-500 G4.
- ▷ Connect the second rod antenna to the **ANT II** socket on the rear side of the EM 300-500 G4.
- ▷ Gently angle the rod antennas to the left and right as shown in the figure.



If you are using more than one receiver, we recommend using remote antennas and, as needed, Sennheiser antenna accessories. For more information, visit the ew G4 product page at [www.sennheiser.com](http://www.sennheiser.com).



## Installing the EM 300-500 G4 in a rack

---

### CAUTION

#### **Rack mounting poses risks**

When installing the device in a closed or multi-rack assembly, please consider that, during operation, the ambient temperature, the mechanical loading and the electrical potentials will be different from those of devices which are not mounted into a rack.

- ▷ Make sure that the ambient temperature within the rack does not exceed the permissible temperature limit specified in the specifications. See “Specifications”.
  - ▷ Ensure sufficient ventilation; if necessary, provide additional ventilation.
  - ▷ Make sure that the mechanical loading of the rack is even.
  - ▷ When connecting to the power supply system, observe the information indicated on the type plate. Avoid circuit overloading. If necessary, provide overcurrent protection.
  - ▷ When rack mounting, please note that intrinsically harmless leakage currents of the individual power supply units may accumulate, thereby exceeding the allowable limit value. As a remedy, ground the rack via an additional ground connection.
-



### Mounting a single receiver in a rack

To mount the receiver in a rack, you will need the GA 3 rack mounting kit (optional accessory).

To fasten the mounting angle of the GA 3 rack mounting kit:

- ▷ Unscrew and remove the two recessed head screws (M4x8) on each side of the receiver.
- ▷ Secure both of the the mounting angles to the sides of the receiver using the previously removed recessed head screws.

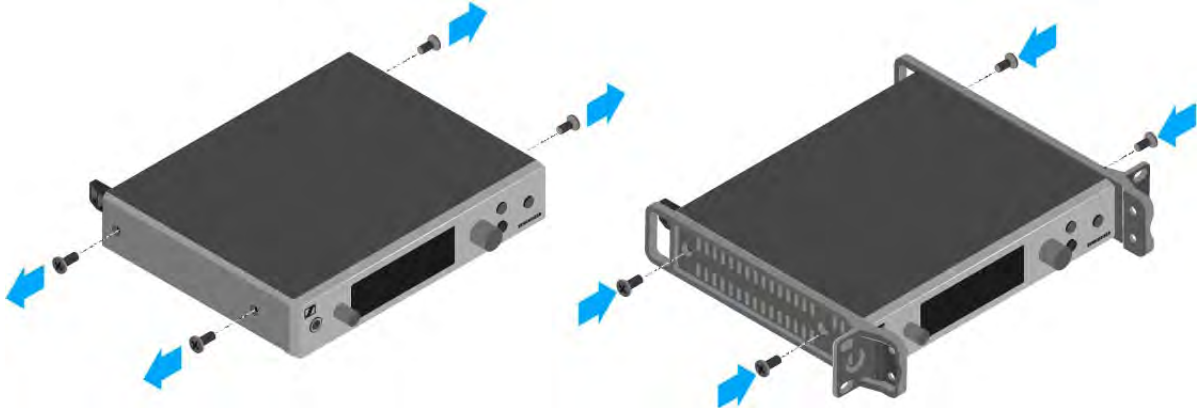

- ▷ Secure the blanking plate to one of the mounting angles using two recessed head screws (M6x10).
- ▷ Attach the AM 2 antenna front mounting set (optional accessory) and mount the rod antennas on the blanking plate (right diagram).

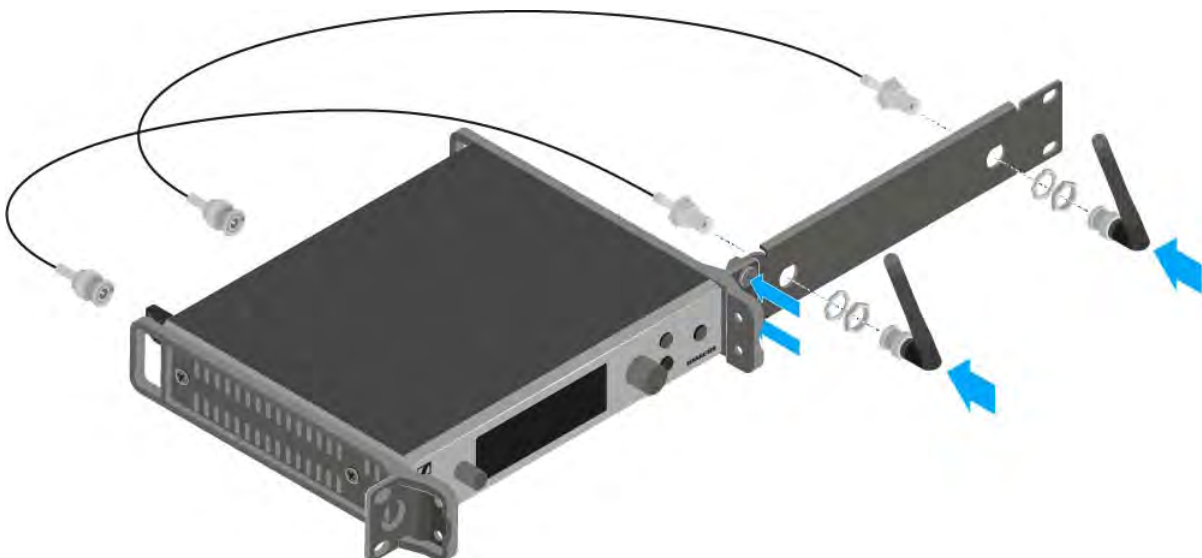

- ▷ Slide the receiver with the mounted blanking plate into the 19" rack.
- ▷ Secure the mounting angle and the blanking plate to the 19" rack.
- ▷ Align the mounted antennas in a V-shape.





### Mounting two receivers side by side in a rack

**i** When you mount two receivers side by side, it is only possible to front mount antennas when you use the ASA 214 antenna splitter in combination with the AM 2 front mounting kit and an additional GA 3 rack mounting kit. See “Installing the ASA 214”.

To mount the receiver using the GA 3 rack mounting kit (optional accessory):

- ▷ Place both receivers upside down and side by side on an even surface.
- ▷ Secure the jointing plate to the transmitters using the six recessed head screws (M3x6).
- ▷ Secure the mounting angle.

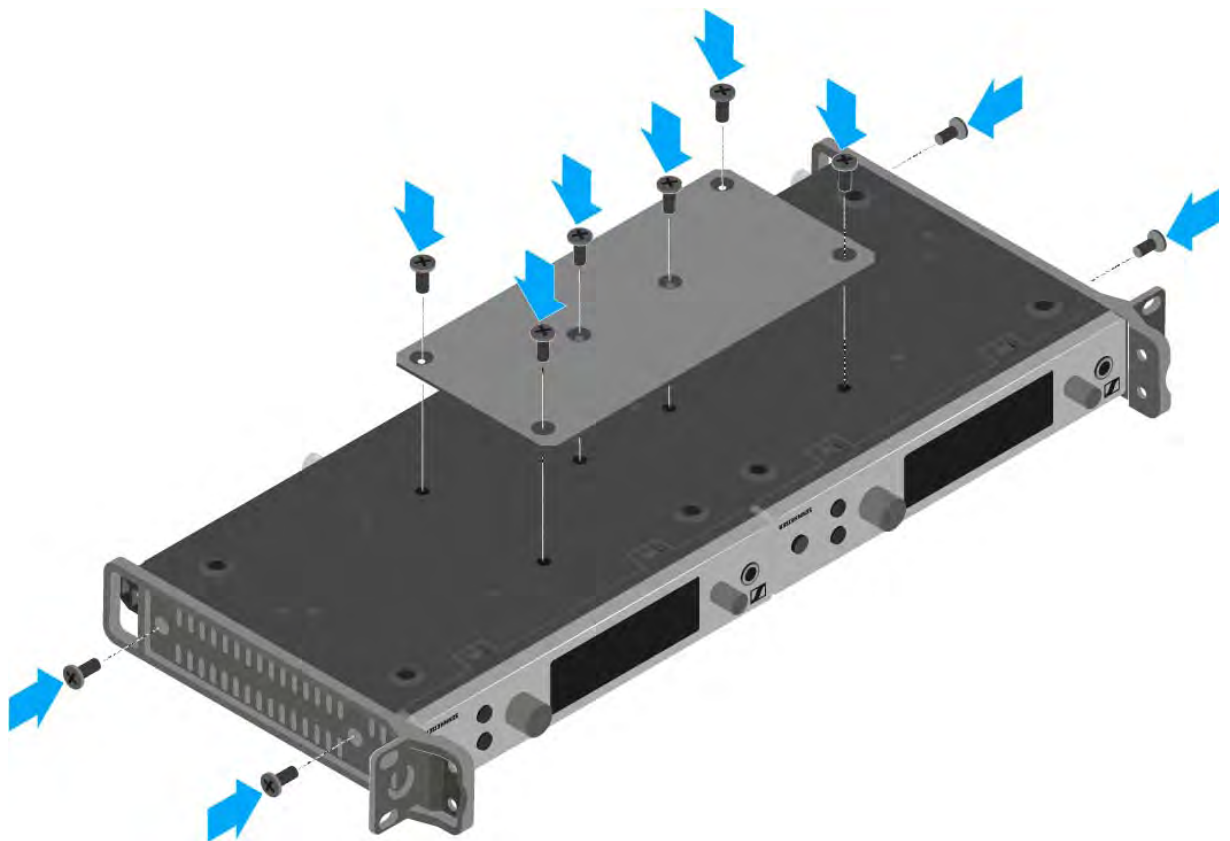



## Installing the SKM 300 G4

These sections contain detailed information about installing and starting up the SKM 300 G4.

You can find information about operating the SKM 300 G4 under “Using the SKM 300 G4”.

### Inserting and removing the batteries/rechargeable batteries

You can operate the wireless microphone either with batteries (AA, 1.5 V) or with the rechargeable Sennheiser BA 2015 battery.

- ▷ Screw the rear part of the wireless microphone in the direction of the arrow (counter-clockwise) off of the handle of the wireless microphone.

**i** When you remove the wireless microphone during operation, mute is automatically activated. **MUTE** appears in the display panel. When you screw the microphone back together, mute is deactivated.

- ▷ Pull the rear part of the wireless microphone all the way out.
- ▷ Open the cover of the battery compartment.
- ▷ Place the batteries or the BA 2015 rechargeable battery in the battery compartment as shown on the cover. Please observe correct polarity when inserting the batteries/accupack.

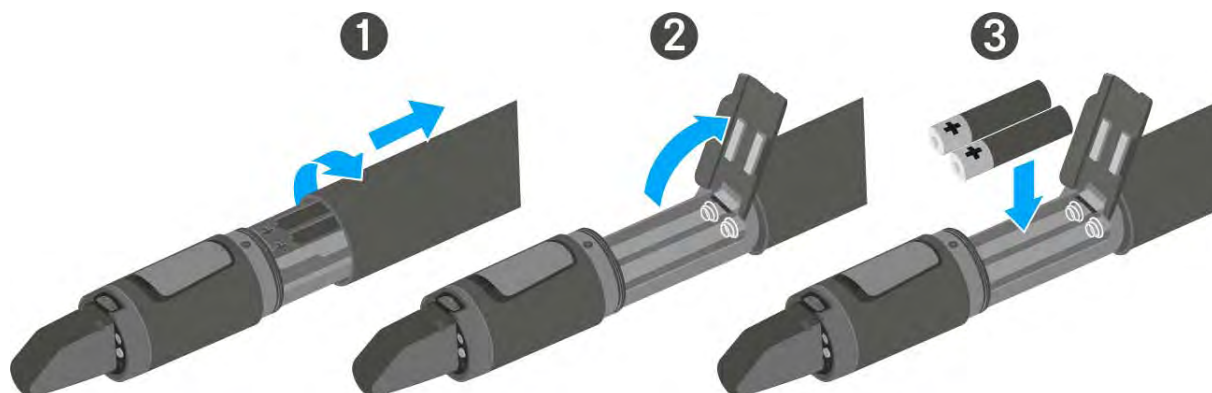

- ▷ Close the cover.
- ▷ Push the battery compartment into the handle of the wireless microphone.
- ▷ Screw the rear part of the wireless microphone back onto the handle.



**Battery status**

Charge status of the batteries:

	100 %	> 8 h
	70 %	4 - 6 h
	30 %	2 - 3 h
LOW BATT		

Charge status is critical (LOW BATT):

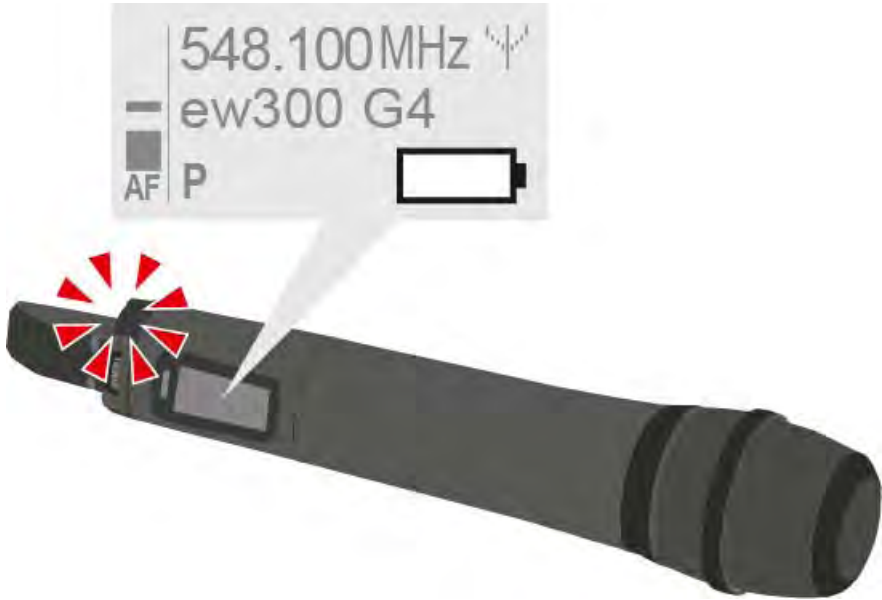



## Replacing the microphone module

You can find a list of the recommended microphone modules for the hand-held transmitter under “Microphones and cables”.

To change the microphone module:

- ▷ Unscrew the microphone module.
- ▷ Screw the desired microphone module on.



---

**i** Do not touch the wireless microphone contacts or the microphone module contacts. If you touch the contacts, they may become dirty or bent.

When you unscrew the microphone module during operation, mute is automatically activated. **MUTE** appears in the display panel. When you screw the microphone module back on, mute is deactivated.

---



## Changing the colored ring

To change the colored ring:

- ▷ Pull the colored ring off as shown in the diagram.

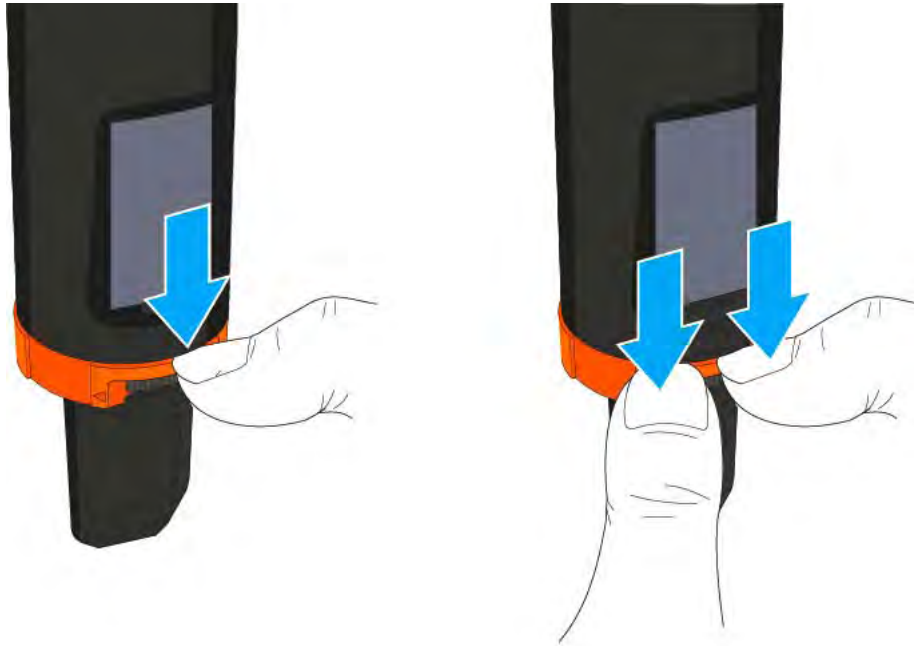

- ▷ Attached a colored ring in the color you want as shown in the diagram.

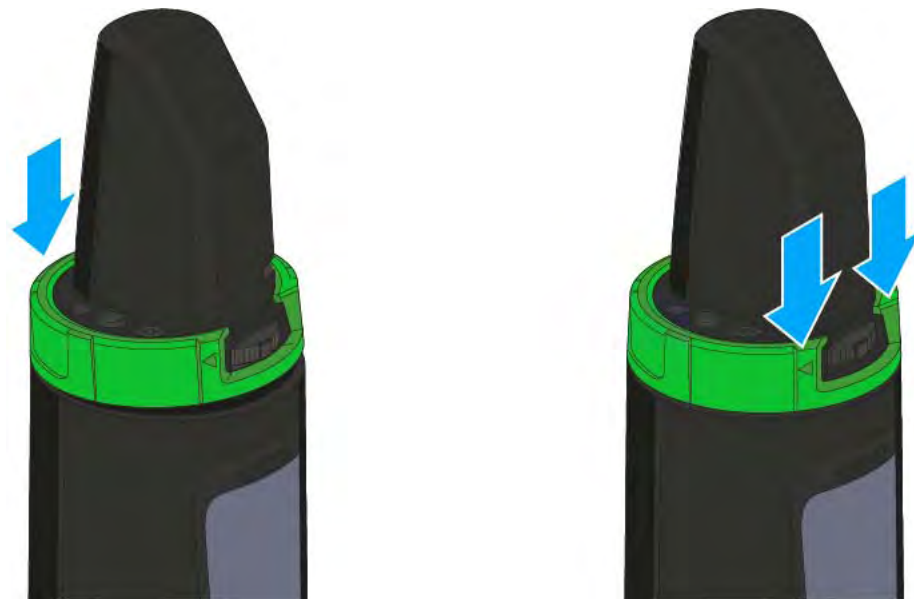



## Installing the SK 300 G4

These sections contain detailed information about installing and starting up the SK 300 G4.

You can find information about operating the SK 300 G4 under “Using the SK 300 G4”.

### Inserting and removing the batteries/rechargeable batteries

You can operate the bodypack transmitter either with batteries (AA, 1.5 V) or with the rechargeable Sennheiser BA 2015 battery.

- ▷ Press the two catches and open the battery compartment cover.
- ▷ Insert the batteries or the rechargeable battery as shown below. Please observe correct polarity when inserting the batteries.









- ▷ Close the battery compartment.  
The cover locks into place with an audible click.



### Battery status

Charge status of the batteries:

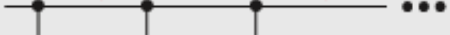
	100 %	> 8 h
	70 %	4 - 6 h
	30 %	2 - 3 h
LOW BATT 	  	

Charge status is critical (LOW BATT):





## Connecting a microphone to the SK 300 G4

You can find a list of recommended Lavalier and headset microphones for the bodypack transmitter under “Microphones and cables”.

To connect a microphone to the bodypack transmitter:

- ▷ Insert the cable's 3.5 mm jack plug into the **MIC/LINE** socket on the bodypack transmitter as shown in the diagram.
- ▷ Screw the plug's coupling ring onto the audio socket thread of the bodypack transmitter.







## Connecting an instrument or line source to the SK 300 G4

You can connect instruments or audio sources with a line level to the bodypack transmitter.

To do this, you will need the **Ci 1-N** (6.3 mm jack plug on a lockable 3.5 mm jack plug) or **CL 2** (XLR-3F plug on lockable 3.5 mm jack plug) Sennheiser cables.

To connect an instrument or line source to bodypack transmitter:

- ▷ Insert the cable's 3.5 mm jack plug into the **MIC/LINE** socket on the bodypack transmitter as shown in the diagram.
- ▷ Screw the plug's coupling ring onto the audio socket thread of the bodypack transmitter.





## Connecting the RMS 1 mute switch to the SK 300

You can control the SK 300 G4 remotely via cable with the RMS 1 remote mute switch.



- 1 **MIC** button
  - See “Using the SK 300 G4 with the RMS 1 remote mute switch”
- 2 **STATUS** LED
  - See “Advanced > MIC LED menu item”
- 3 2.5 mm jack plug

To connect the RMS 1 to the SK 300 G4:

- ▷ Insert the 2.5 mm jack plug of the RMS 1 into the 2.5 mm jack socket of the SK 300.

This deactivates the function of the **MUTE** switch of the SK 300 G4.



You can find information about operating the RMS 1 under “Using the SK 300 G4 with the RMS 1 remote mute switch”.



## Attaching the bodypack transmitter to clothing

You can use the belt clip to attach the bodypack transmitter to your waistband or on a guitar strap.

The belt clip is detachable so that you can also attach the bodypack transmitter with the antenna pointing downwards. To do so, withdraw the belt clip from its fixing points and attach it the other way round.

The belt clip is secured so that it cannot slide out of its fixing points accidentally.



To detach the belt clip:

- ▷ Lift the belt clip as shown in the diagram.
- ▷ Press one side of the clip downward on the fixing hole and pull it out of the transmitter housing.
- ▷ Do the same thing on the other side.

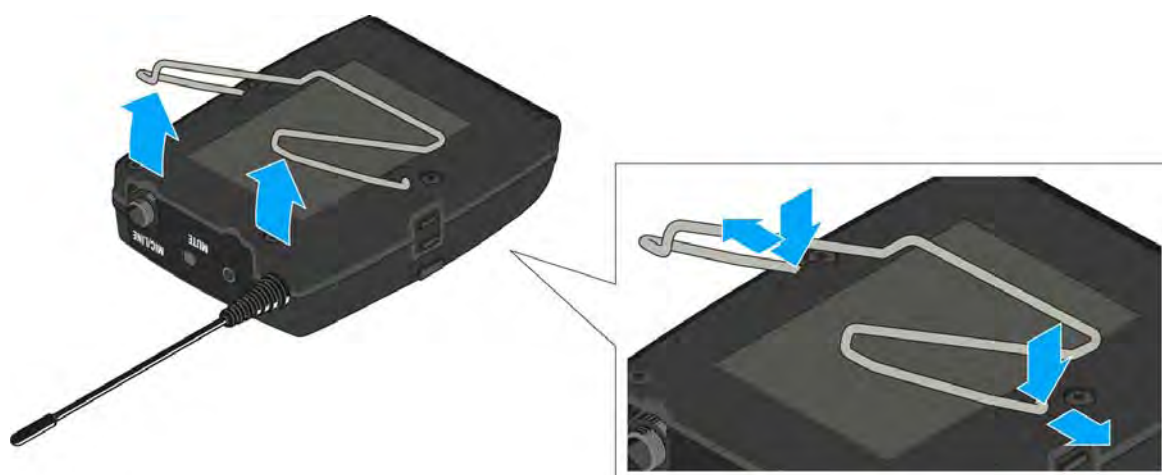



## Installing the ASA 214

These sections contain detailed information about installing and starting up the ASA 214.

You can find information about operating the ASA 214 under “Using the ASA 214”.

### Connectors on the rear of the device

[Product overview for the rear side of the ASA 214](#)

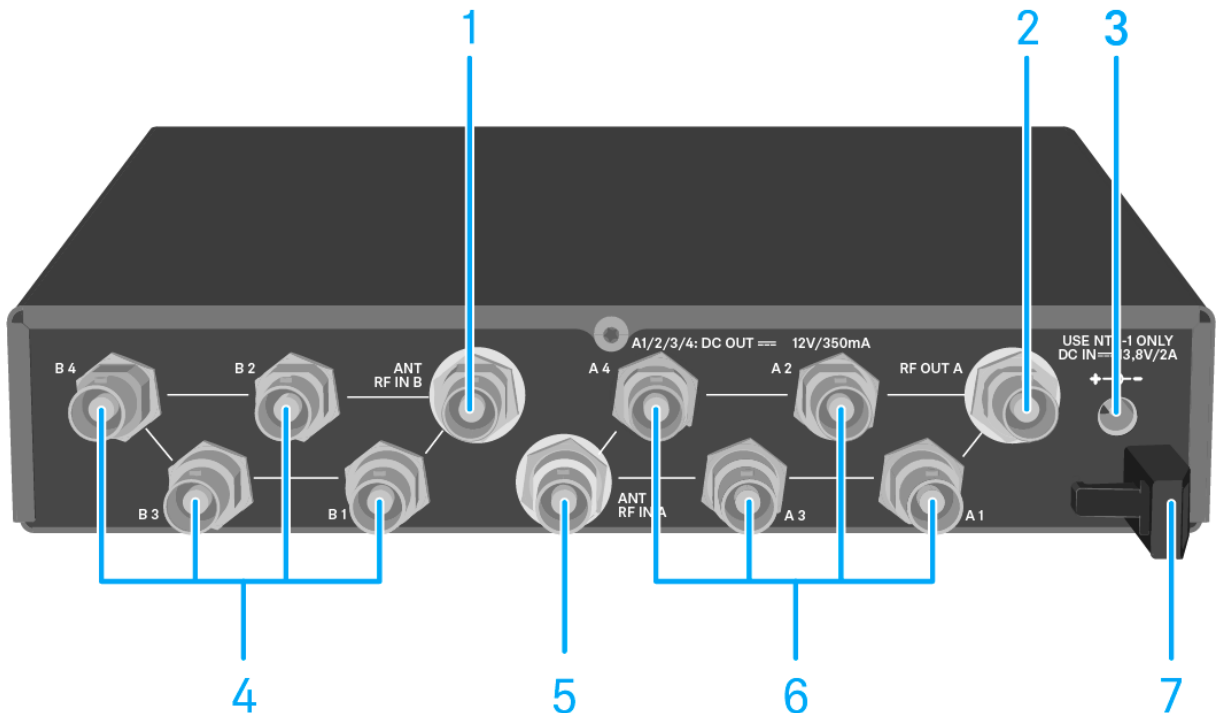

- 1 **ANT RF IN B** BNC socket
  - Antenna input of diversity branch B
  - See “Connecting antennas”
- 2 **RF OUT A** BNC socket
  - RF output only for connecting an additional ASA 214 to build an 8-channel diversity system
  - See “Configuring multi-channel systems”
- 3 **DC IN** socket
  - To connect the NT 1-1 power supply unit
  - See “Connecting/disconnecting the ASA 214 to/from the power supply system”
- 4 4 BNC sockets **B1** to **B4**
  - RF outputs of diversity branch B for connection to the receiver
  - See “Connecting receivers to the ASA 214”
- 5 **ANT RF IN A** BNC socket
  - Antenna input of diversity branch A
  - See “Connecting antennas”



- 6 4 BNC sockets **A1** to **A4**
  - RF outputs of diversity branch A for connection to the receiver
  - Every one of these RF outputs can also provide voltage to a receiver.
  - See “Connecting receivers to the ASA 214”
- 7 Strain relief for the cable of the power supply unit
  - See “Connecting/disconnecting the ASA 214 to/from the power supply system”

## Connecting/disconnecting the ASA 214 to/from the power supply system

To supply power to the ASA 214, the connected receivers and any antenna amplifiers used, you will need the NT 1-1 power supply unit.

Only use the supplied NT 1-1 power supply unit. It is designed for your antenna splitter and ensures safe operation.

To connect the ASA 214 antenna splitter to the power supply system:

- ▷ Plug the hollow jack plug of the power supply unit into the **DC IN** socket of the antenna splitter.
- ▷ Pass the cable of the power supply unit through the cable grip.
- ▷ Slide the supplied country adapter onto the power supply unit.
- ▷ Plug the power supply unit into the wall socket.

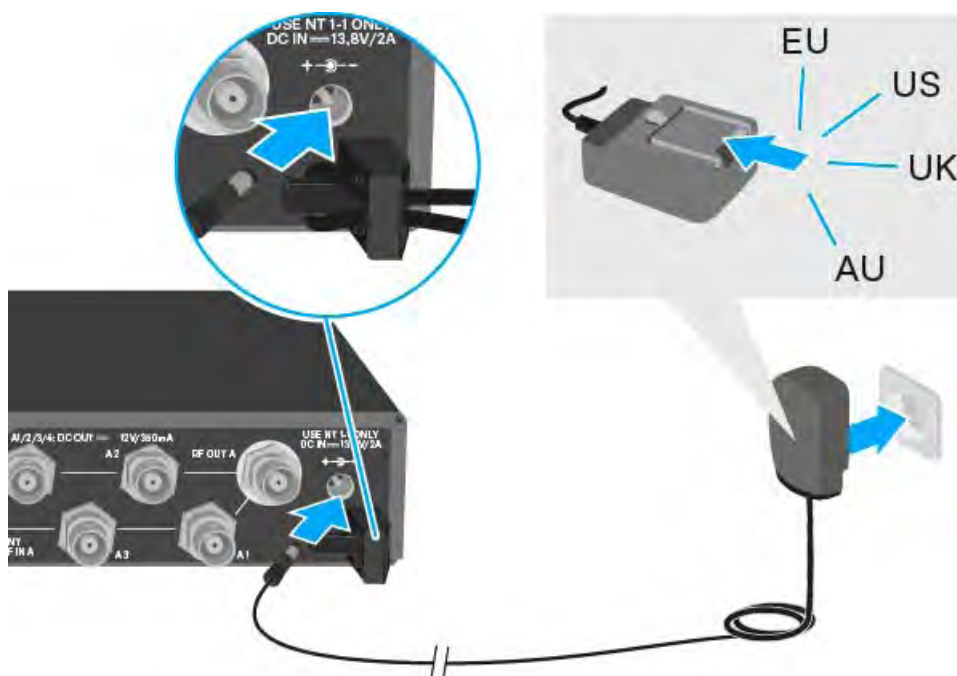

To completely disconnect the ASA 214 antenna splitter from the power supply system:

- ▷ Unplug the power supply unit from the wall socket.
- ▷ Unplug the hollow jack plug of the power supply unit from the **DC IN** socket of the antenna splitter.



## Connecting receivers to the ASA 214

You can connect and operate up to four stationary receivers to the ASA 214.

Sennheiser receivers of the ew G4 and ew G3 series can also be supplied with power from the ASA 214.

The following receivers are compatible:

### evolution wireless G4:

- EM 100 G4
- EM 300-500 G4

### evolution wireless G3:

- EM 100 G3
- EM 300 G3
- EM 500 G3

### 2000 series:

- EM 2000 (with its own power supply)
- EM 2050 (with its own power supply)

To connect the receivers to the ASA 214 antenna splitter:

- ▷ Connect one of the receiver's antenna inputs to one of the BNC sockets **A1** to **A4** using one of the supplied BNC cables.

The compatible receivers listed above do not require their own power supply. They are powered via the BNC sockets **A1** to **A4**.

- ▷ Connect the receiver's other antenna input to one of the BNC sockets **B1** to **B4** using one of the supplied BNC cables.

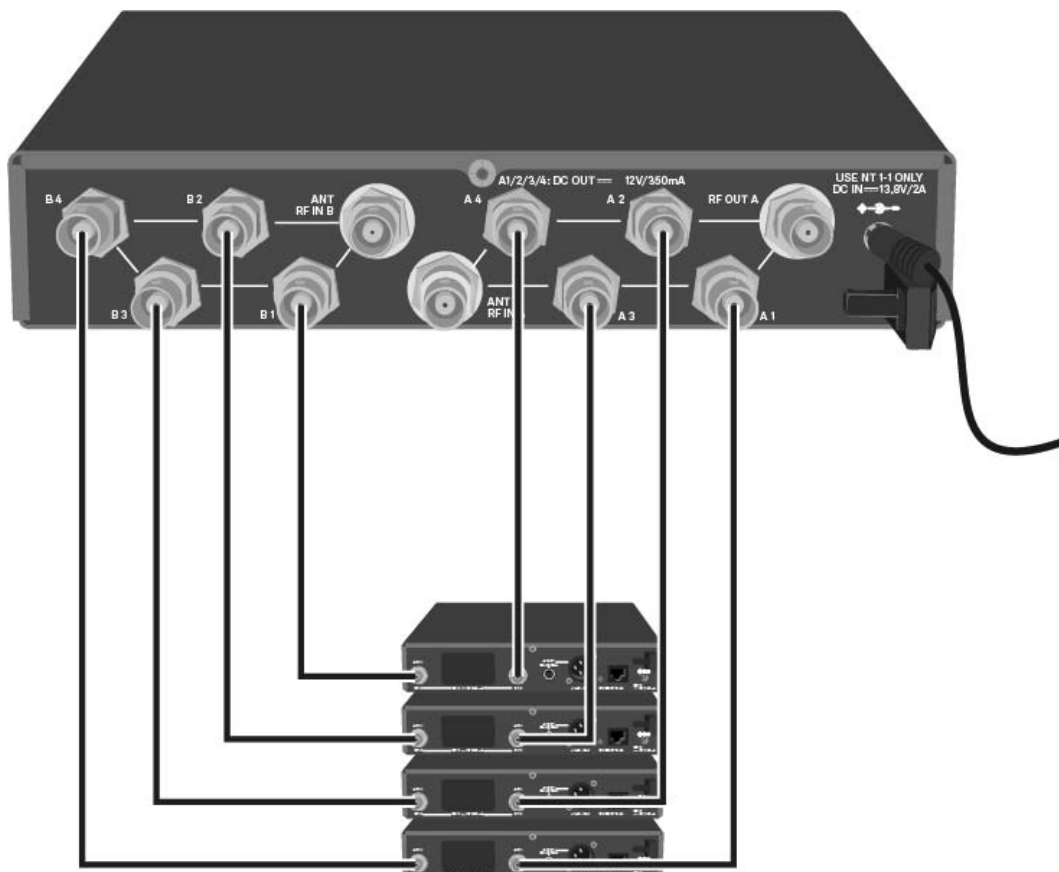



## Connecting antennas

**i** For more information about antennas and antenna accessories, see “Antennas and accessories”.

**i** In order to ensure optimal reception even in the case of poor reception conditions, we recommend using remote antennas.

### Connecting remote antennas

- ▷ Mount two antennas or a combination of an antenna and an antenna amplifier to the BNC sockets **ANT RF IN A** and **ANT RF IN B**.



### Connecting rod antennas

- ▷ Mount the antennas to the BNC sockets **ANT RF IN A** and **ANT RF IN B**.
- ▷ Align the antennas in a V-shape in order to ensure the best possible reception.



## Information on antenna amplifiers and cable lengths

The following table shows which cable lengths require the use of the AB 3 antenna amplifier as well as the maximum recommended cable lengths.

Device	Frequency range around	Number of AB 3	Max. cable length	
			RG 58	GZL 5000
ASA 214	500 MHz	0	8 m	16 m
		1	36 m	72 m
		2	64 m	128 m
	700 MHz	0	7 m	14 m
		1	30 m	60 m
		2	53 m	106 m
	900 MHz	0	6 m	12 m
		1	26 m	52 m
		2	46 m	92 m
ASA 214 - 1G8	1800 MHz	0	4 m	8 m
		1	16 m	36 m
		2	28 m	64 m





## Configuring multi-channel systems

The following options for connecting multi-channel systems are possible:

### Option 1: Two antennas supply a 4-channel system

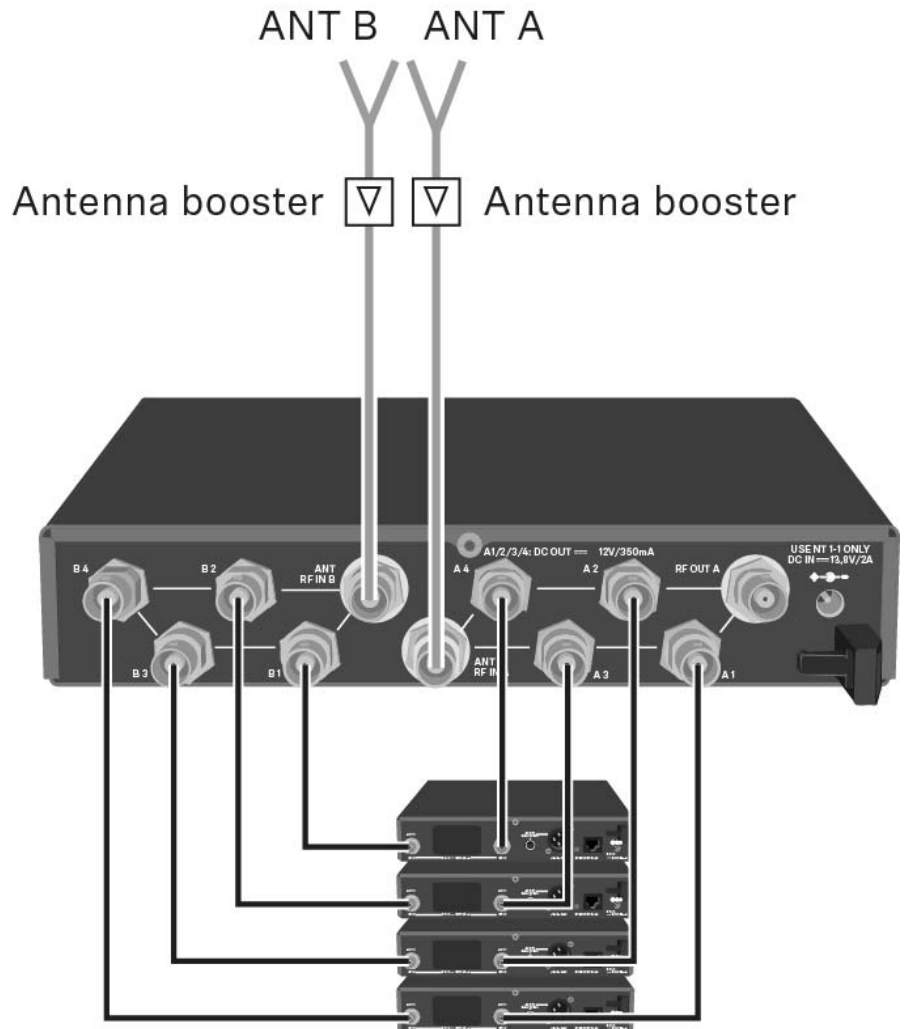



Option 2: Two 4-channel systems are interconnected

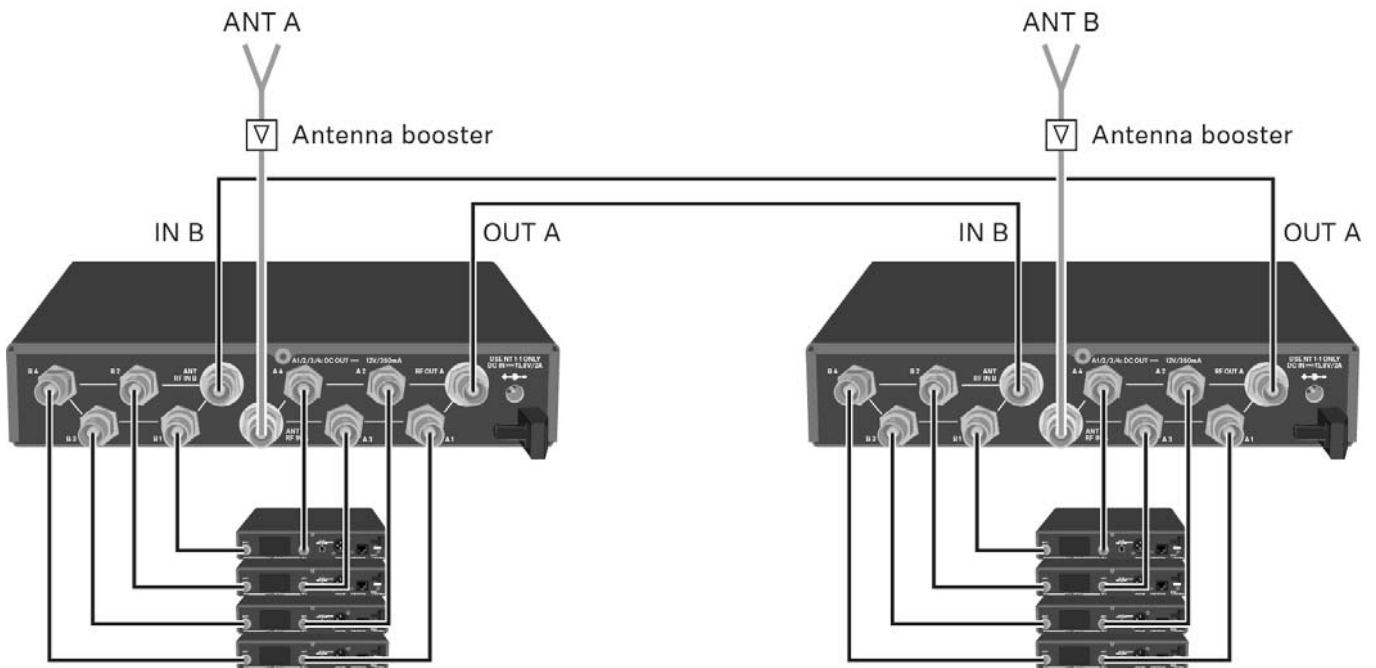

Option 3: Two antennas supply a 8-channel system

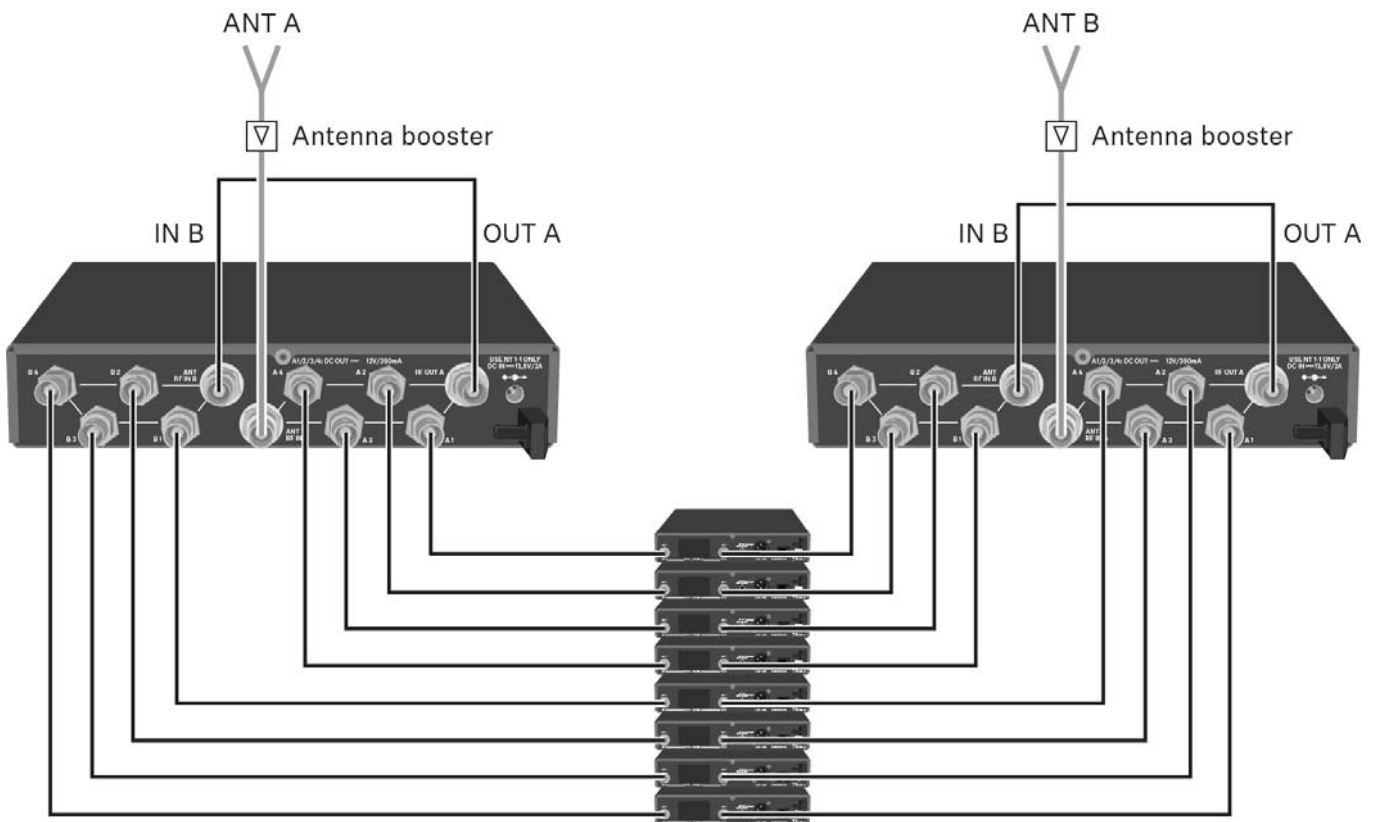



## Installing the ASA 214 in a rack

---

### CAUTION

#### **Rack mounting poses risks**

When installing the device in a closed or multi-rack assembly, please consider that, during operation, the ambient temperature, the mechanical loading and the electrical potentials will be different from those of devices which are not mounted into a rack.

- ▷ Make sure that the ambient temperature within the rack does not exceed the permissible temperature limit specified in the specifications. See “Specifications”.
  - ▷ Ensure sufficient ventilation; if necessary, provide additional ventilation.
  - ▷ Make sure that the mechanical loading of the rack is even.
  - ▷ When connecting to the power supply system, observe the information indicated on the type plate. Avoid circuit overloading. If necessary, provide overcurrent protection.
  - ▷ When rack mounting, please note that intrinsically harmless leakage currents of the individual power supply units may accumulate, thereby exceeding the allowable limit value. As a remedy, ground the rack via an additional ground connection.
-



### Mounting a single antenna splitter in a rack

To mount the antenna splitter in a rack, you will need the GA 3 rack mounting kit (optional accessory).

To fasten the mounting angle of the GA 3 rack mounting kit:

- ▷ Unscrew and remove the two recessed head screws (M4x8) on each side of the antenna splitter.
- ▷ Secure the mounting angles to the sides of the antenna splitter using the previously removed recessed head screws.

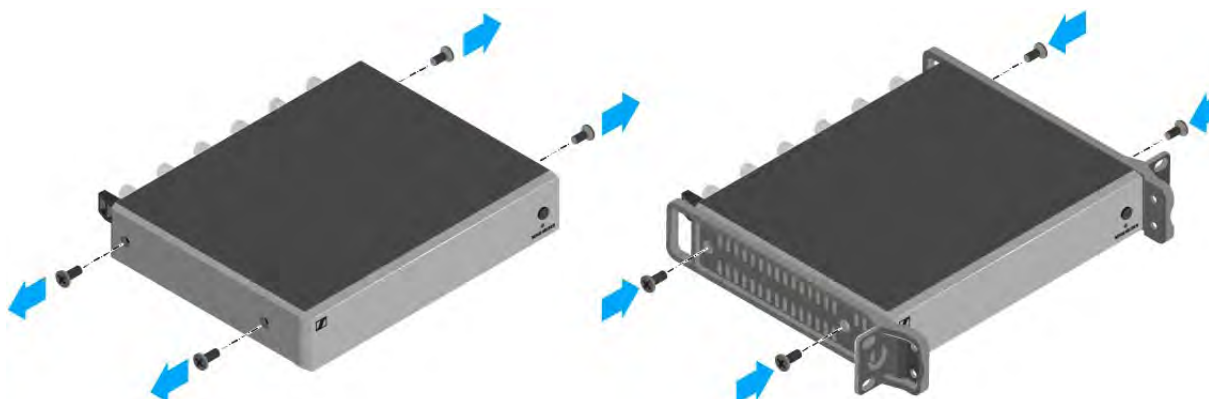

- ▷ Secure the blanking plate to one of the mounting angles using two recessed head screws (M6x10).

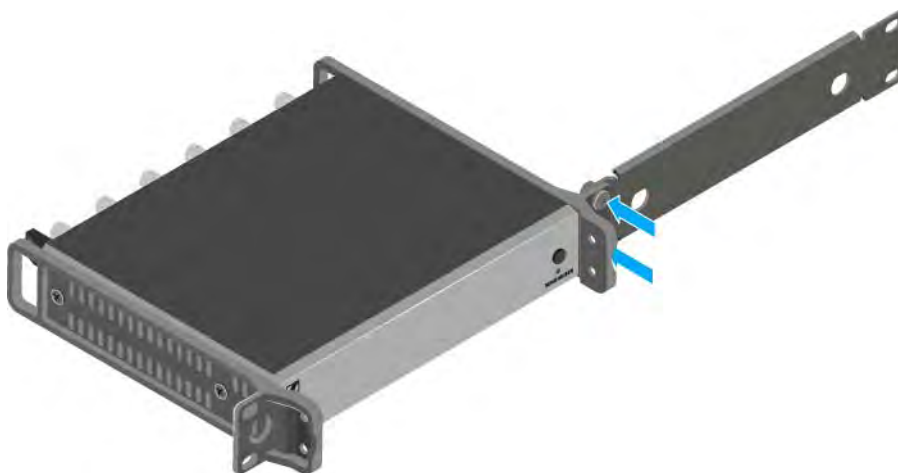



- ▷ Attach the antennas. You have the following options:
  - Connect the supplied rod antennas on the rear side of the antenna splitter. In this case, cover the antenna holes with the two covers (left diagram).
  - Attach the AM 2 antenna front mounting set (optional accessory) and mount the rod antennas on the blanking plate (right diagram).



- ▷ Slide the antenna splitter with the mounted blanking plate into the 19" rack.
- ▷ Secure the mounting angle and the blanking plate to the 19" rack.
- ▷ Align the mounted antennas in a V-shape.



### Mounting two antenna splitters side by side in a rack

To mount the antenna splitters using the GA 3 rack mounting kit (optional accessory):

- ▷ Place both antenna splitters upside down and side by side on an even surface.
- ▷ Secure the jointing plate to the transmitters using the six recessed head screws (M3x6).
- ▷ Secure the mounting angle.

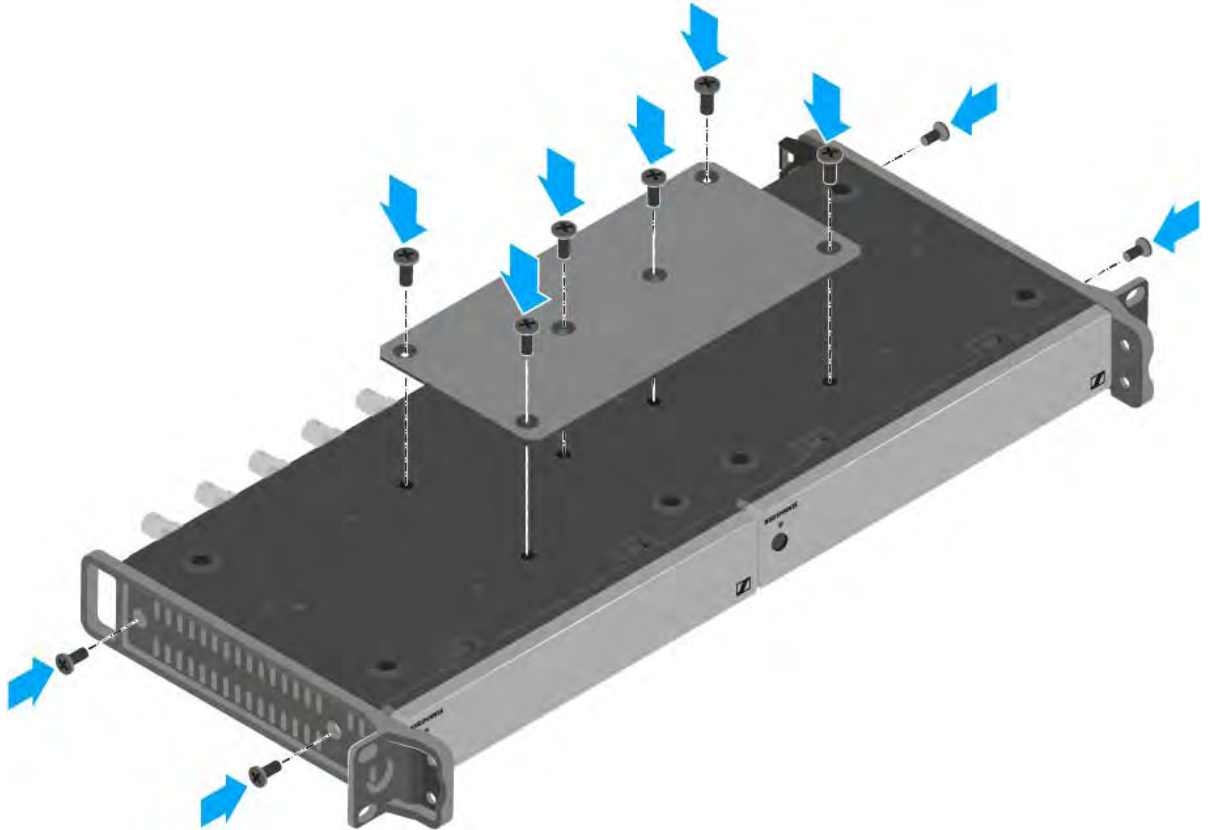



## Using the EM 300-500 G4

These sections contain detailed information about using the EM 300-500 G4.

You can find information on installation and startup of the EK 300-500 G4 under “Installing the EM 300-500 G4”.

### Operating elements on the front of the device

#### Product overview for the front of the EM 300-500 G4

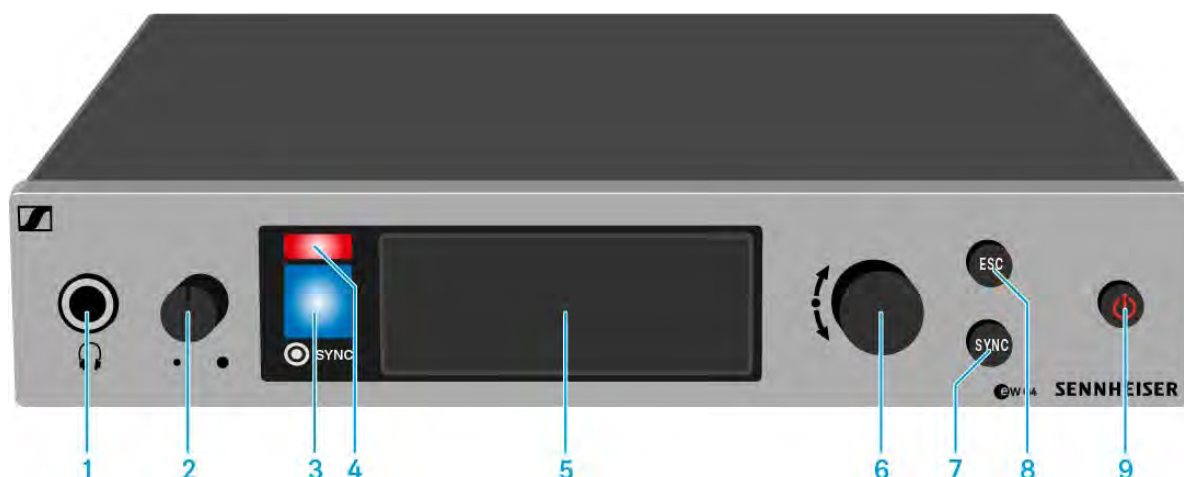

- 1 Headphone socket
  - See “Using the headphone output”
- 2 Volume control for the headphone socket
  - See “Using the headphone output”
- 3 Infrared interface with a blue LED
  - See “Synchronizing devices”
- 4 Red LED for warnings
  - See “Advanced -> Fullscreen Warnings menu item”
- 5 Display panel
  - See “Displays on the EM 300-500 G4 display panel”
- 6 **Jog dial** for navigating through the menu
  - See “Buttons for navigating through the menu”
- 7 **SYNC** button
  - See “Synchronizing devices”
- 8 **ESC** button
  - See “Buttons for navigating through the menu”
- 9 **STANDBY** button
  - See “Switching the EM 300-500 G4 on and off”



## Switching the EM 300-500 G4 on and off

To switch the receiver on:

- ▷ Short-press the **STANDBY** button.  
The receiver switches on and the **Receiver Parameters** standard display appears.



To switch the receiver to **standby mode**:

- ▷ If necessary, deactivate the lock-off function (see “Lock-off function”).
- ▷ Press and hold the **STANDBY** button until **OFF** appears on the display panel.  
The display panel switches off.

To **completely switch** the receiver **off**:

- ▷ Disconnect the receiver from the power supply system by unplugging the power supply unit from the wall socket.





## Muting the audio output

To **mute** the audio signal of the receiver:

- ▷ Press the **STANDBY** button in one of the standard displays.  
The **RX Mute On?** display appears.
- ▷ Press the **SET** button.  
The audio signal is muted.

To **cancel the muting**:

- ▷ Press the **STANDBY** button.  
The **RX Mute Off?** display appears.
- ▷ Press the **SET** button.  
The audio output is no longer muted.

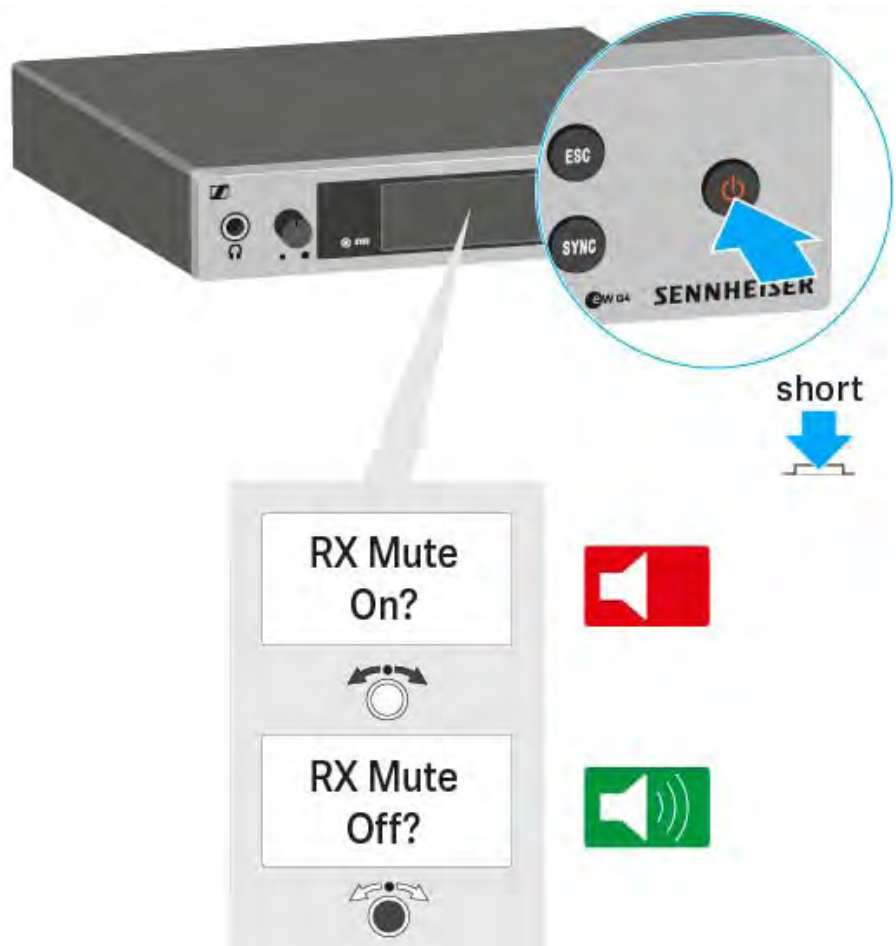



## Using the headphone output

You can use the headphone output on the front of the EM 300-500 G4 (6.3 mm jack) to listen to the audio signal.

---

### ATTENTION



#### Danger due to high volume levels

Volume levels that are too high may damage your hearing.

- ▷ Turn down the volume of the headphone output before you put on the headphone.
- ▷ Increasing the volume of the audio output **AF Out** (see “AF Out menu item”) to more than +18 dB also increases the volume of the headphone output.

- 
- ▷ Connect the headphone to the headphone socket.
  - ▷ Control the volume by turning the volume control next to the headphone socket.





## Lock-off function

You can set the automatic lock-off function in the **Auto lock** menu (see “Auto Lock menu item”).

When you have switched on the lock-off function, you will have to turn the receiver off and on again in order to operate it.

To temporarily deactivate the lock-off function:

- ▷ Press the **jog dial**.  
Locked appears in the display panel.
- ▷ Turn the **jog dial**.  
Unlock? appears in the display panel.
- ▷ Press the **jog dial**.  
Lock-off function is now temporarily deactivated.

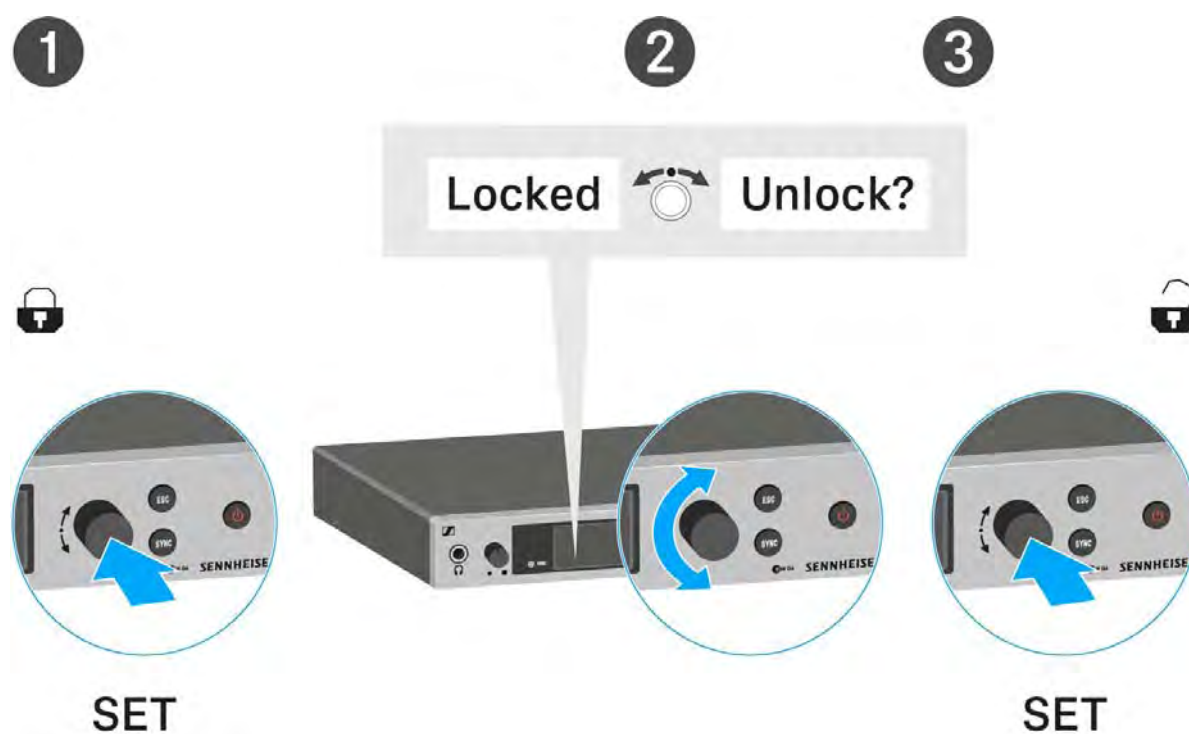

### When you are in the operating menu

>> Lock-off function is deactivated long enough for you to work in the operating menu.

### When one of the standard displays is shown

>> Lock-off function is automatically activated after 10 seconds.

The lock-off function icon flashes while the lock-off function is being activated again.



## Displays on the EM 300-500 G4 display panel

---

**Status information** such as reception quality, battery status, audio level, etc. is displayed on the **home screen** of the display panel. See “Home screen”.

---

The display panel also displays the **operating menu**, which you can use to configure all of the **settings**. See “Setting options in the menu”.

---



## Buttons for navigating through the menu

To navigate through the EM 300-500 G4 operating menu, you need the following buttons.

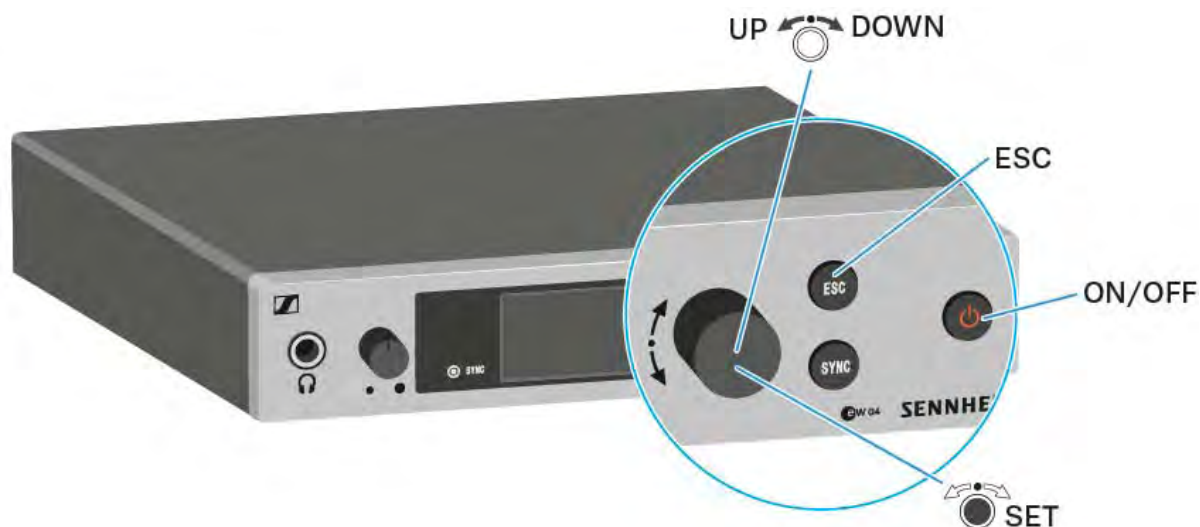

Short-press the **ESC** button

- Cancels the entry and returns to the previous display

Long-press the **ESC** button

- Cancels the entry and returns to the home screen



Press the **jog dial**

- Changes from the current standard display to the operating menu
- Calls up a menu item
- Changes to a submenu
- Stores the settings and returns to the operating menu



Turn the **jog dial**

- Selects a standard display (see “Home screen”)
- Changes to the previous or next menu item
- Changes the setting of a menu item



## Home screen

After you switch on the receiver, the display panel initially displays the Sennheiser logo. After a short time, the home screen is then displayed.

The home screen has three different standard displays.

- On the home screen, turn the **jog dial** to switch between the standard displays.

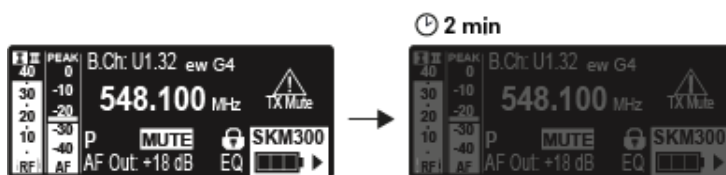

The display is dimmed automatically after 2 minutes of inactivity.



If there is no radio link to a transmitter, the display switches off after 20 minutes. The display can be reactivated by pressing any button.

---



### Receiver Parameters standard display

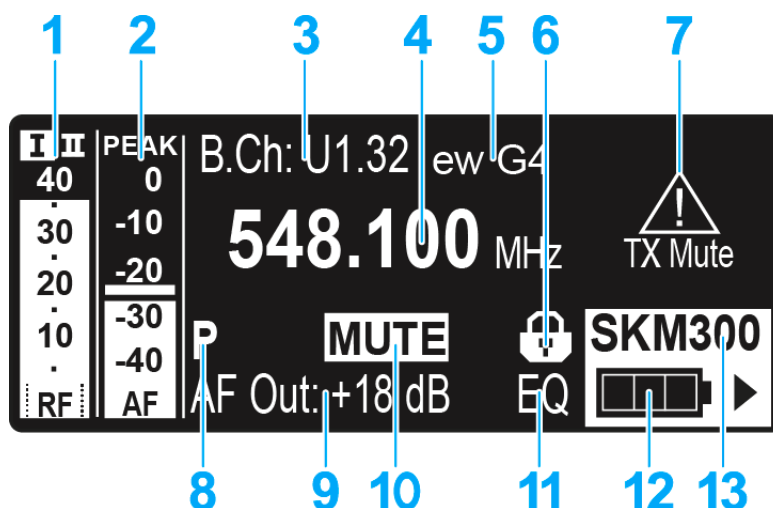

- 1 **RF** RF level (radio frequency)
  - RF signal level display
  - including the display of the squelch threshold (see “Squelch menu item”)
- 2 **AF** audio level (audio frequency)
  - Displays the audio level of the received transmitter  
When the display shows full deflection, the audio input level is excessively high. When the transmitter is overloaded frequently or for extended periods of time, the **PEAK** display is shown inverted.
  - See “AF Out menu item”
- 3 Frequency bank and channel
  - Current frequency bank and channel number
  - See “Frequency Preset menu item”
- 4 Frequency
  - Current receiving frequency
  - See “Frequency Preset menu item”
- 5 Name
  - Freely selectable name of the receiver
  - See “Name menu item”
- 6 Lock-off function
  - Lock-off function is activated on the receiver
  - See “Lock-off function”
- 7 Warnings
  - Activated warning messages are displayed
  - See “Advanced -> Fullscreen Warnings menu item”
- 8 **P** pilot tone
  - Activated pilot tone evaluation
  - See “Advanced -> Pilot Tone menu item”
- 9 Output gain
  - Current output gain of the audio frequency signal at the 6.3 mm socket / XLR socket
  - See “AF Out menu item”



### 10 Equalizer setting

- Current equalizer setting
- See “Equalizer menu item”

### 11 MUTE muting function

- Receiver or transmitter is muted
- See “Muting the audio output”

### 12 Battery status of the transmitter

- SKM 300 G4: see “Inserting and removing the batteries/rechargeable batteries”
- SKM 500 G4: see “Inserting and removing the batteries/rechargeable batteries”
- SK 300 G4: see “Inserting and removing the batteries/rechargeable batteries”
- SK 500 G4: see “Inserting and removing the batteries/rechargeable batteries”

### 13 Transmitter type

- Product name of the connected transmitter

### Transmitter Parameters [standard display](#)

The Transmitter Parameters standard display shows the microphone module (only for SKM) and the transmitter type.

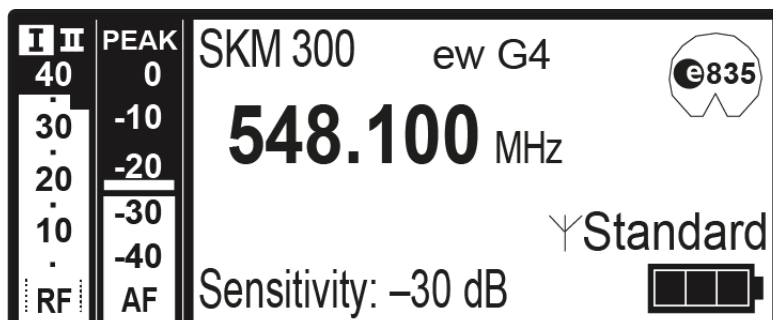





### Soundcheck standard display

The Soundcheck standard display shows the transmission quality between the transmitter and the receiver.

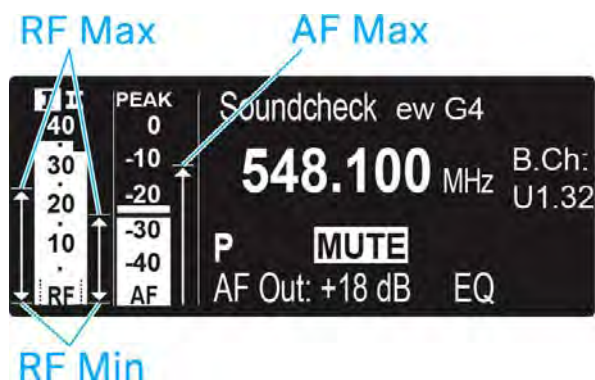

By doing a soundcheck, you can ensure adequate transmission quality in the entire area in which you want to use the transmitter. You can do the soundcheck without the help of another person.

- ▷ With the transmitter, walk up and down the area in which you want to use the transmitter.

The receiver records the following parameters:

#### RF Min

- Minimum RF signal level
- must be well above the squelch threshold level for one of the two antennas

#### Ways to optimize

- ▷ Check that the antennas and the antenna cables are correctly connected.
- ▷ Improve the position of the antennas.
- ▷ If necessary, use an antenna booster.

#### RF Max

- Maximum RF signal level
- both antennas should reach 40 dBμV

#### Ways to optimize

- ▷ Check that the antennas and the antenna cables are correctly connected.
- ▷ Improve the position of the antennas.
- ▷ If necessary, use an antenna booster.

#### AF Max

- Maximum audio level

#### Ways to optimize

- ▷ On your transmitter, adjust the audio level as high as possible without the display for the audio level showing full deflection (**AF Max** is at a level with the **PEAK** display), see “AF Out menu item”.



## Setting options in the menu

In the EM 300-500 G4 menu, you can configure the following settings.

---

### Adjusting the squelch threshold

- ▷ See “Squelch menu item”
- 

### Scanning for unused frequency presets, releases and selects frequency presets

- ▷ See “Easy Setup menu item”
- 

### Setting the frequency bank and the channel

- ▷ See “Frequency Preset menu item”
- 

### Entering a freely selectable name

- ▷ See “Name menu item”
- 

### Adjusting the audio output level

- ▷ See “AF Out menu item”
- 

### Adjusting the frequency response of the output signal

- ▷ See “Equalizer menu item”
- 

### Activating/deactivating automatic lock-off function

- ▷ See “Auto Lock menu item”
- 

### Configuring enhanced settings in the **Advanced Menu**:

- Setting the receiving frequencies for the frequency banks U1 to U6
- Activating/deactivating the parameters to be transferred to the transmitters
- Activating/deactivating the pilot tone evaluation
- Activating/deactivating warnings
- Adjusting the contrast of the display panel
- Resetting the receiver
- Adjusting the network configuration
- Displaying the current software revision
- ▷ See “Advanced menu item”



### Menu structure

The figure shows the complete EM 300-500 G4 menu structure in an overview.

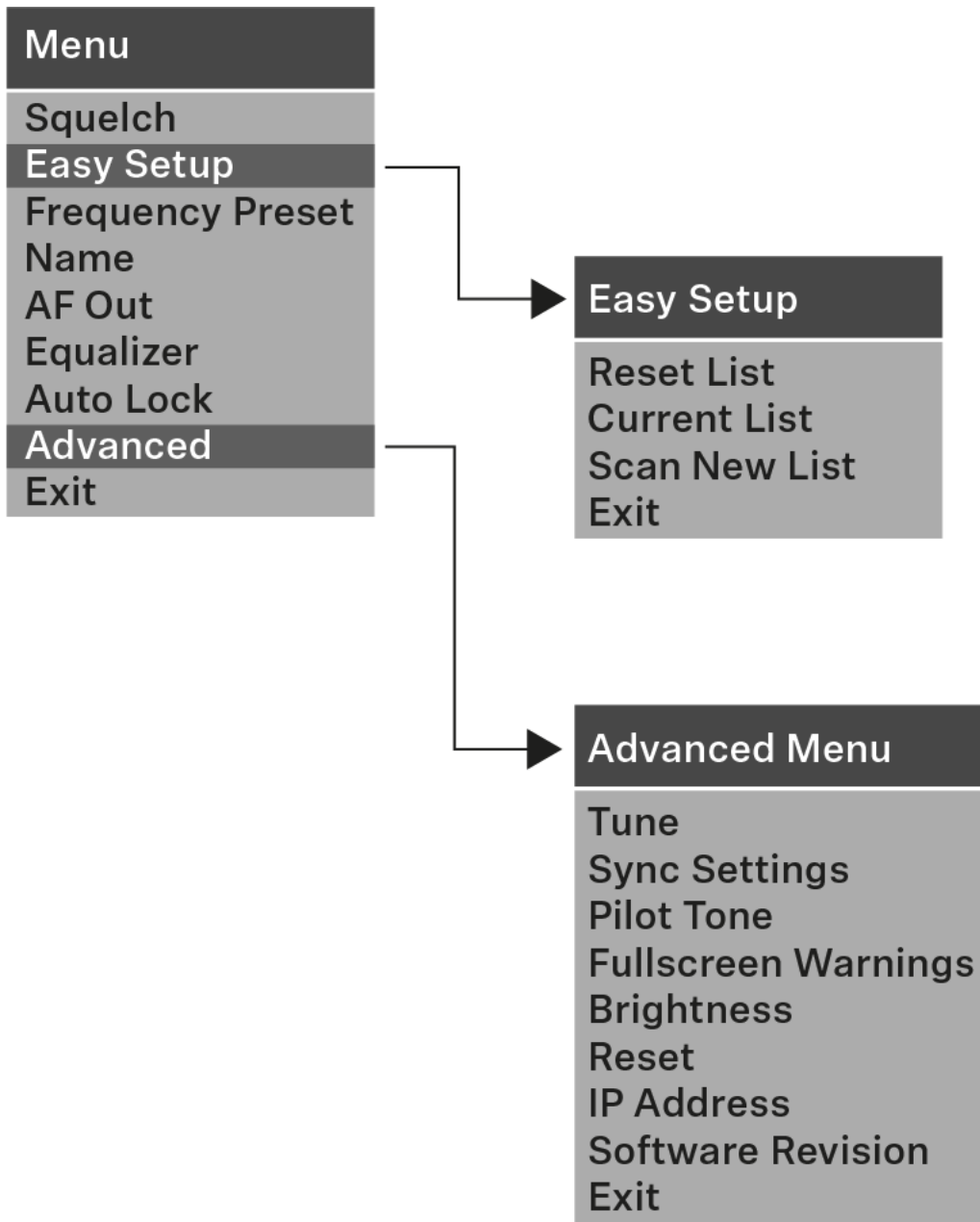



## Squelch menu item

You can adjust the squelch threshold in the **Squelch** menu item.

### Setting range:

- 5 to 25 dB $\mu$ V, adjustable in 2-dB steps

The squelch threshold is displayed on the home screen in the RF signal level area.

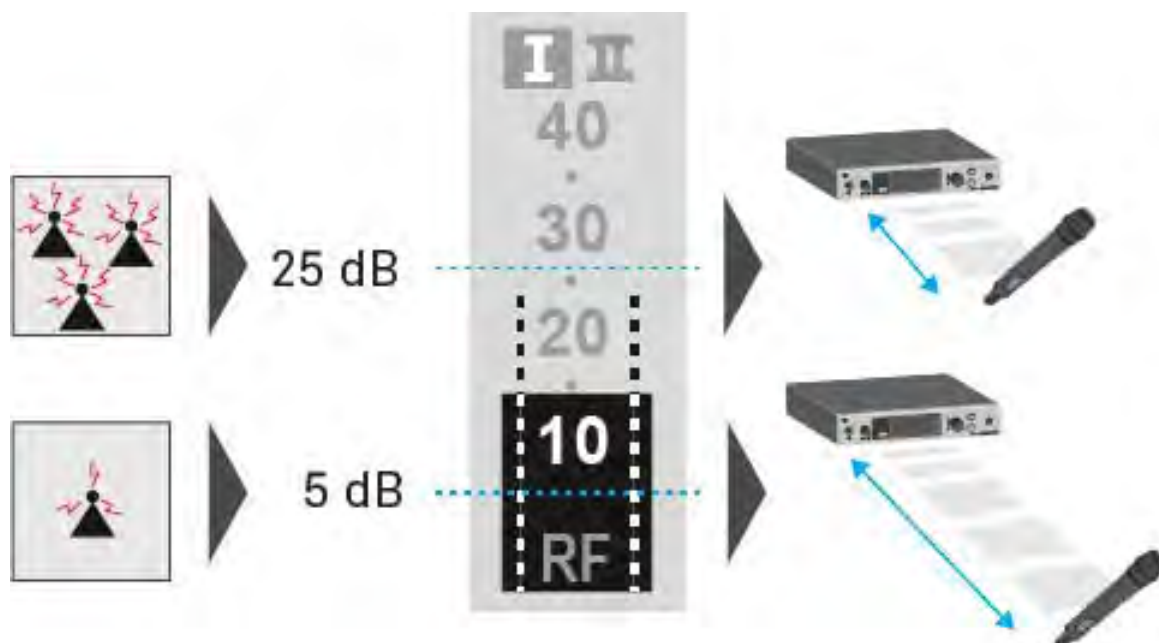

---

### CAUTION

#### Risk of hearing and material damage

If you set the squelch threshold to a very low value, a very loud hissing noise can occur in the receiver. This hissing noise can be loud enough to cause hearing damage or overload your system's loudspeakers.

- ▷ Before adjusting the squelch threshold, set the volume of the audio output to the minimum.
  - ▷ Never change the squelch threshold during a live transmission.
-



To open the **Squelch** menu item:

- ▷ On the home screen, press the **jog dial** to open the operating menu.
- ▷ Turn the **jog dial** until the Squelch menu item appears in the selection frame.
- ▷ Press the **jog dial** to open the menu.
- ▷ Adjust the settings as desired.

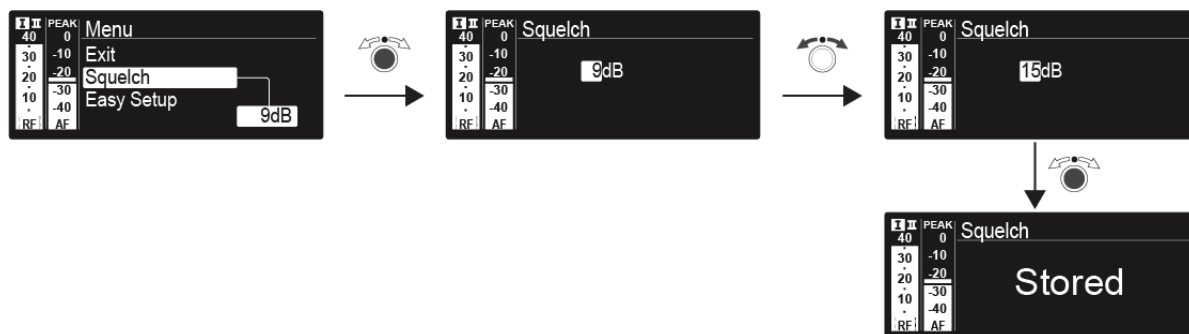

- ▷ Press the **jog dial** to save your selection.
- or
- ▷ Press the **ESC** button to cancel the entry without saving the setting.



## Easy Setup menu item

You can scan for unused frequencies using the **Easy Setup** menu item.

When you have connected multiple EM 300-500 G4 devices to a network via the RJ-45 interfaces (see “Creating a data network”), you can perform the frequency setup for all of the connected receivers.



Switch off all transmitters before you perform the scan. If transmitters are still switched on, they are detected as unavailable frequencies and the frequencies that are actually available cannot then be used.

To open the **Easy Setup** menu item:

- ▷ On the home screen, press the **jog dial** to open the operating menu.
- ▷ Turn the **jog dial** until the **Easy Setup** menu item appears in the selection frame.
- ▷ Press the **jog dial** to open the menu.

### Scan New List



- ▷ Select **Scan New List** to scan for unused frequencies.
- ▷ Press the **jog dial** to start the scan.  
The frequency range of the receiver is scanned. As a result, the number of unused frequencies is displayed for every frequency bank.
- ▷ Turn the **jog dial** to select a frequency bank.
- ▷ Press the **jog dial** to confirm your selection.
- ▷ Turn the **jog dial** to select an unused frequency from the selected bank.
- ▷ Press the **jog dial** to save your selection and synchronize the selected frequency with the transmitter at a later point (see “Synchronizing devices”).

or



- ▷ Press the **SYNC** button to synchronize the selected frequency with the transmitter immediately.

### Current List

- ▷ Select **Current List** to show the list of unused frequencies from the last scan.

### Reset

- ▷ Select **Reset List** to delete the list of unused frequencies.

### Performing multi-channel frequency setup

---

**i** As an alternative to the following procedure, multi-channel frequency setup can also be performed using the **Sennheiser Wireless Systems Manager (WSM)** software. For more information about controlling devices via the **Sennheiser Wireless Systems Manager (WSM)** software, refer to the instruction manual for the software. You can download the software here:

[www.sennheiser.com/wsm](http://www.sennheiser.com/wsm)

---

To perform the automatic frequency setup for multiple radio links simultaneously:

- ▷ Connect all of the receivers to one network using a network switch. See “Creating a data network”.
- ▷ Please note that all receivers must be in the same **IP address range**.
  - The IP addresses can be **automatically** assigned if there is a DHCP server in the network.
  - If there is no DHCP server in the network, the IP addresses must be assigned **manually**. See “Advanced -> IP Address menu item”.
  - Assign the IP addresses for all receivers in the **192.168.x.x** range (the link-local range **169.254.x.x** is also a possible alternative).
- ▷ Open the **Easy Setup** menu item on one of the receivers. This receiver is the master. You can choose any receiver to be the master.



- ▷ Perform the frequency scan on the master receiver as described above.
- ▷ From the scan results in the master receiver, select a frequency bank with enough free channels.

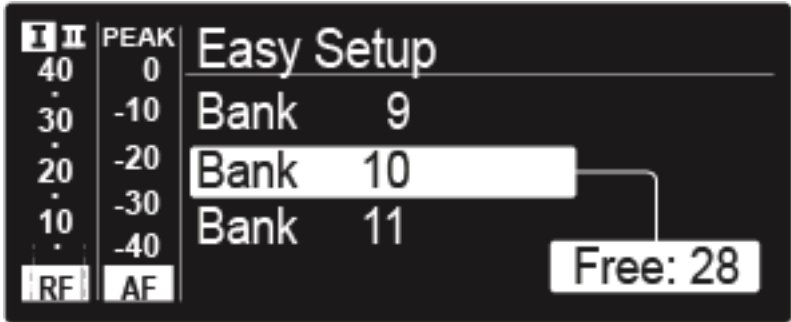

After you make your selection, the display panels of the other receivers will display the message [Assign New Frequency?](#).

Receivers with non-compatible frequency ranges will display the message [Unassignable Frequency!](#).

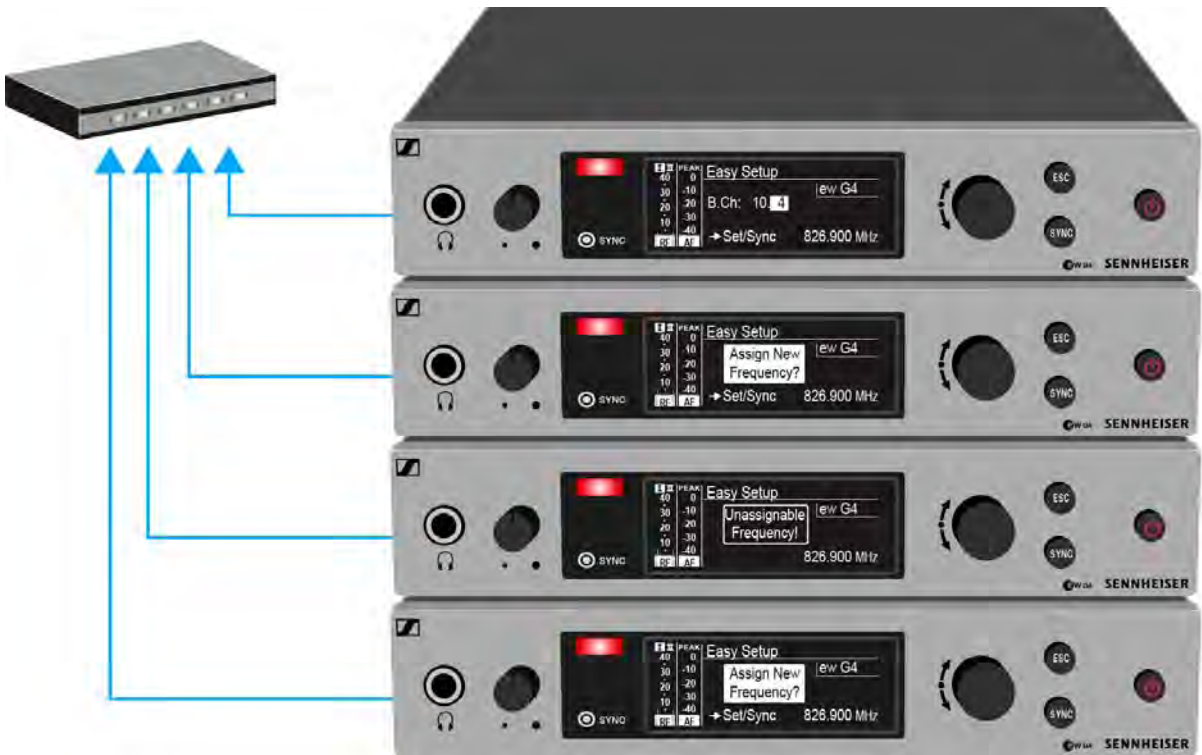





- ▷ Select an unused frequency for one of the connected receiver on the master receiver.

The frequency selected on the master receiver will also be shown on the display panel of the connected receivers.

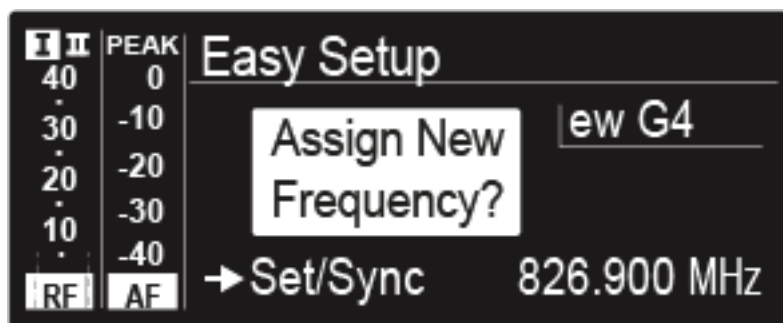

- ▷ Press the jog dial (**SET**) on the particular receiver to save your selected frequency and synchronize it with the corresponding transmitter at a later point (see “Synchronizing devices”).

or

- ▷ Press the **SYNC** button to synchronize the selected frequency with the transmitter immediately.
- ▷ Use this procedure to assign an unused frequency to all connected receivers, one after another.
- ▷ For the last step, assign a frequency to the master receiver. This completes the multi-channel frequency setup.



## Frequency Preset menu item

In the **Frequency Preset** menu item, you can adjust the receiving frequency of the receiver by adjusting the frequency bank and the channel.

To open the **Frequency Preset** menu item:

- ▷ On the home screen, press the **jog dial** to open the operating menu.
- ▷ Turn the **jog dial** until the **Frequency Preset** menu item appears in the selection frame.
- ▷ Press the **jog dial** to open the menu.
- ▷ Adjust the settings as desired.

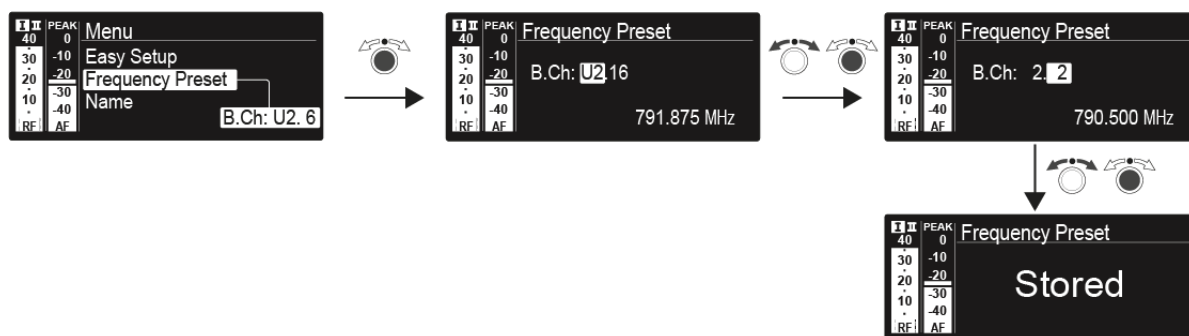

- ▷ Press the **jog dial** to save your selection.  
or
- ▷ Press the **ESC** button to cancel the entry without saving the setting.

**i** You can set the frequencies of the frequency bank **U** here: “Advanced -> Tune menu item”



## Name menu item

In the **Name** menu item you can enter a name for the radio link.

To open the **Name** menu item:

- ▷ On the home screen, press the **jog dial** to open the operating menu.
- ▷ Turn the **jog dial** until the **Name** menu item appears in the selection frame.
- ▷ Press the **jog dial** to open the menu.
- ▷ Adjust the settings as desired.

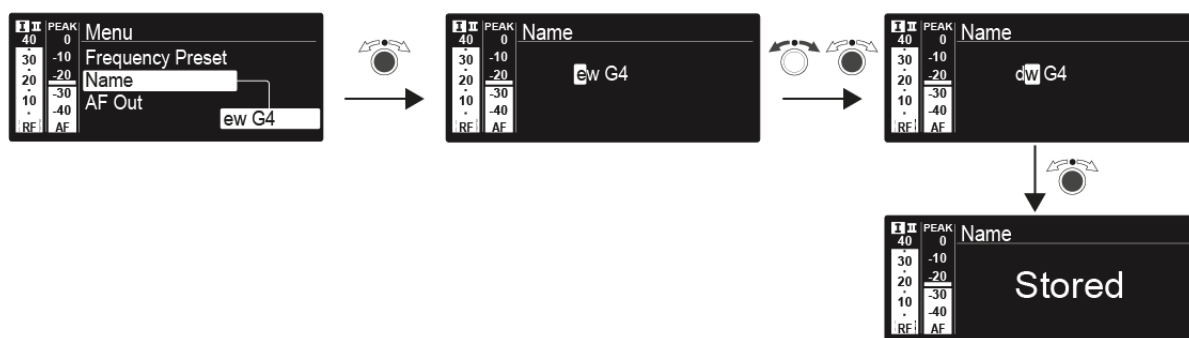

- ▷ Press the **jog dial** to save your selection.
- or
- ▷ Press the **ESC** button to cancel the entry without saving the setting.



## AF Out menu item

In the **AF Out** menu item, you can set the audio level that is output via the receiver audio outputs.

### Setting range:

- -24 dB to +24 dB in 3 dB steps

To open the **AF Out** menu item:

- ▷ On the home screen, press the **jog dial** to open the operating menu.
- ▷ Turn the **jog dial** until the **AF Out** menu item appears in the selection frame.
- ▷ Press the **jog dial** to open the menu.
- ▷ Adjust the settings as desired.

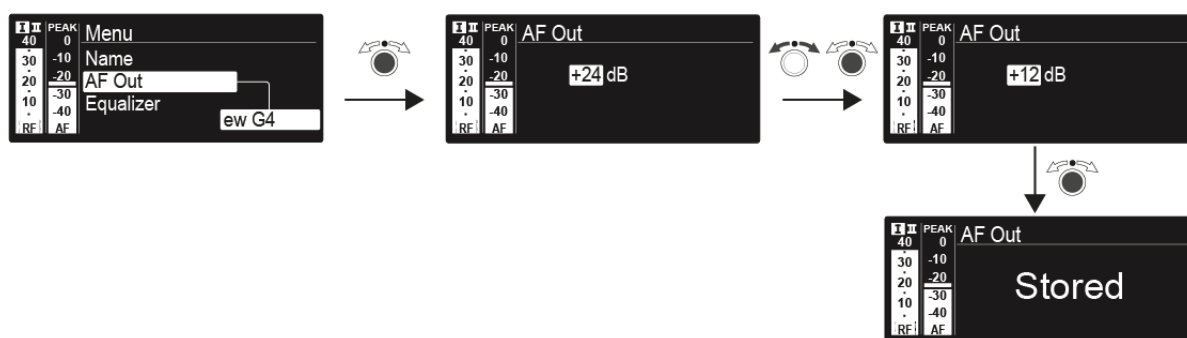

- ▷ Press the **jog dial** to save your selection.  
or
- ▷ Press the **ESC** button to cancel the entry without saving the setting.



## Equalizer menu item

In the **Equalizer** menu item, you can change the frequency response of the output signal. You can reduce the bass range and boost the treble range.

To open the **AF Out** menu item:

- ▷ On the home screen, press the **jog dial** to open the operating menu.
- ▷ Turn the **jog dial** until the **AF Out** menu item appears in the selection frame.
- ▷ Press the **jog dial** to open the menu.
- ▷ Adjust the settings as desired.

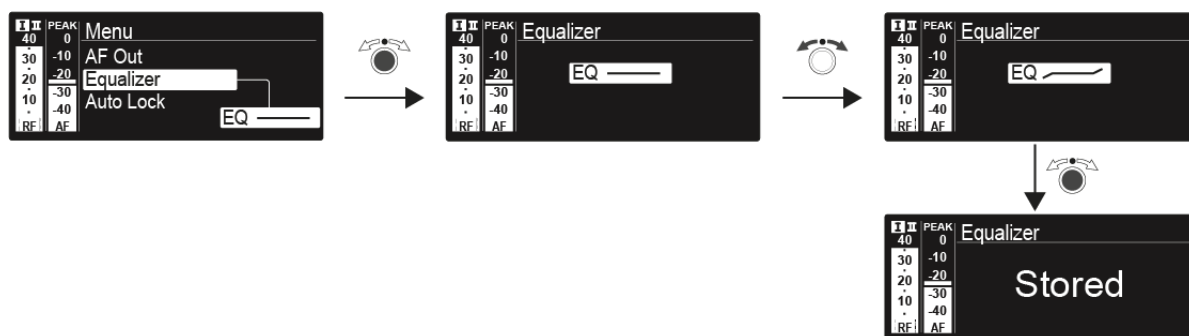

- ▷ Press the **jog dial** to save your selection.
- or
- ▷ Press the **ESC** button to cancel the entry without saving the setting.



## Auto Lock menu item

In the **Auto Lock** menu item you can activate or deactivate the auto lock-off function.

**i** You can find information about temporarily deactivating the lock-off function during operation under “Lock-off function”.

To open the **Auto Lock** menu item:

- ▷ On the home screen, press the **jog dial** to open the operating menu.
- ▷ Turn the **jog dial** until the **Auto Lock** menu item appears in the selection frame.
- ▷ Press the **jog dial** to open the menu.
- ▷ Adjust the settings as desired.

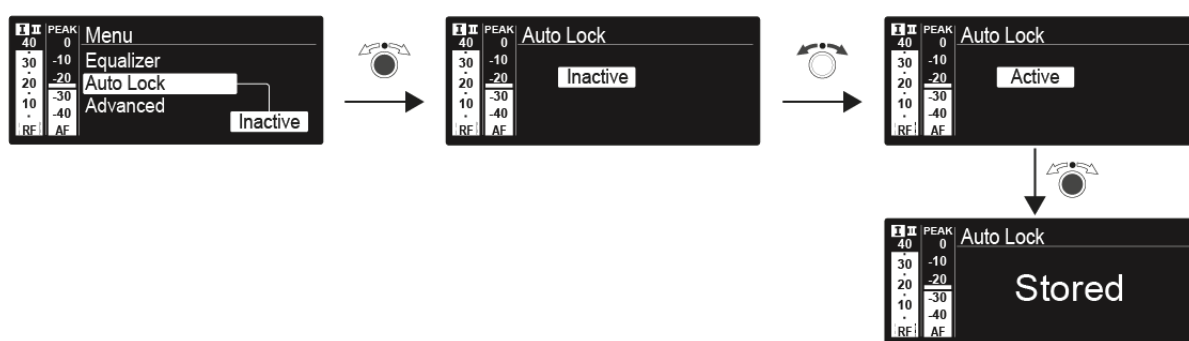

- ▷ Press the **jog dial** to save your selection.
- or
- ▷ Press the **ESC** button to cancel the entry without saving the setting.



## Advanced menu item

In the **Advanced** submenu you can configure enhanced settings.

To open the **Advanced** submenu:

- ▷ On the home screen, press the **jog dial** to open the operating menu.
- ▷ Turn the **jog dial** until the **Advanced** menu item appears in the selection frame.
- ▷ Press the **jog dial** to open the menu.

The following sub-items are available:

---

### Adjusting the receiving frequency for the frequency bank U

- ▷ See “Advanced -> Tune menu item”

---

### Receiving frequency

- ▷ See “Advanced -> Sync Settings menu item”

---

### Activating/deactivating the pilot tone evaluation

- ▷ See “Advanced -> Pilot Tone menu item”

---

### Activating/deactivating warnings

- ▷ See “Advanced -> Fullscreen Warnings menu item”

---

### Adjusting the contrast of the display panel

- ▷ See “Advanced -> Brightness menu item”

---

### Resetting the receiver

- ▷ See “Advanced -> Reset menu item”

---

### Adjusting the network configuration

- ▷ See “Advanced -> IP Address menu item”

---

### Displaying the current software revision

- ▷ See “Advanced -> Software Revision menu item”



## Advanced -> Tune menu item

In the **Tune** menu item of the **Advanced** submenu, you can configure the receiving frequencies for the frequency banks **U1** to **U6**.

You can save a total of 32 frequencies in the **U** frequency bank.

### Only adjusting the frequency

Open the **Tune** menu item in the **Advanced** menu.

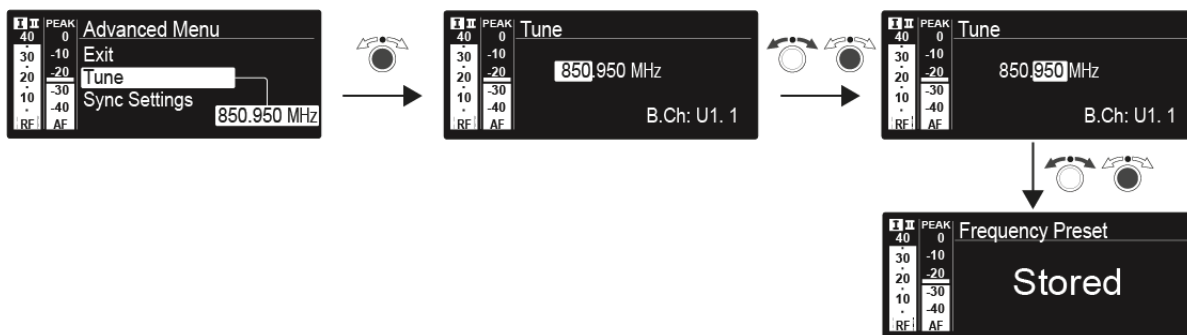

- ▷ Press the **jog dial** to save your selection.  
or
- ▷ Press the **ESC** button to cancel the entry without saving the setting.

### Setting the channel and frequency

- ▷ Select the **Tune** menu item and call it up by holding down the **SET** button until the channel selection appears.
- ▷ Adjust the settings.

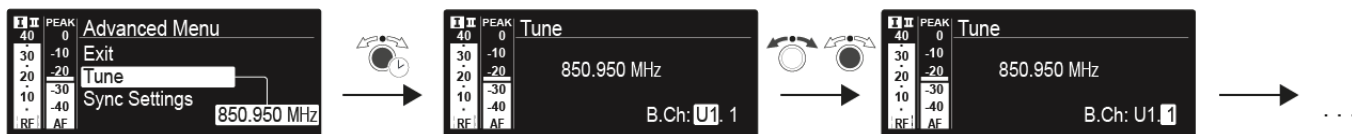

- ▷ Press the **jog dial** to save your selection.  
or
- ▷ Press the **ESC** button to cancel the entry without saving the setting.





## Advanced -> Sync Settings menu item

In the **Sync Settings** menu item of the **Advanced** submenu, you can configure the parameters to be sent to the transmitters and activate or deactivate transmission. The parameters are defined separately for the SK, SKM and SKP.

You can activate/deactivate the following parameters:

- Sensitivity
- Auto Lock
- Mute Mode
- RF Power
- Phantom Power 48 V (only SKP)

To configure a parameter and activate or deactivate transmission:

- ▷ Go to the parameter in question in the **Advanced -> Sync Settings** menu.
- ▷ Press the **jog dial** to open the sub-item.
- ▷ Turn the **jog dial** to set the value.
- ▷ Press the **jog dial** to save your setting.
- ▷ Turn the **jog dial** to activate or deactivate the check box.

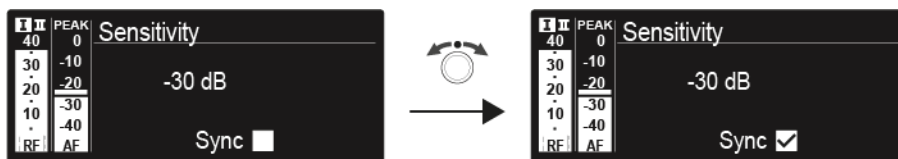

When the check box is activated, the value will be transmitted during synchronization. If it is deactivated, the value will not be transmitted.

- ▷ Press the **jog dial** to save your setting.

## Advanced -> Pilot Tone menu item

In the **Pilot Tone** menu item of the **Advanced** submenu, you can activate and deactivate the pilot tone evaluation.

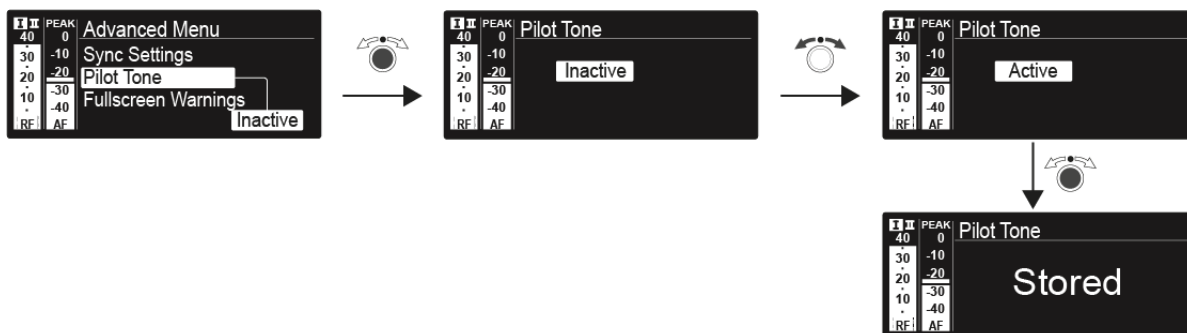

The pilot tone has an inaudible frequency that is sent from the transmitter and evaluated by the receiver. It supports the receiver's squelch function.



### Advanced -> Fullscreen Warnings menu item

In the **Warnings** menu item of the **Advanced** submenu, you can activate or deactivate warnings for certain cases. The warning in question will flash across the entire screen.

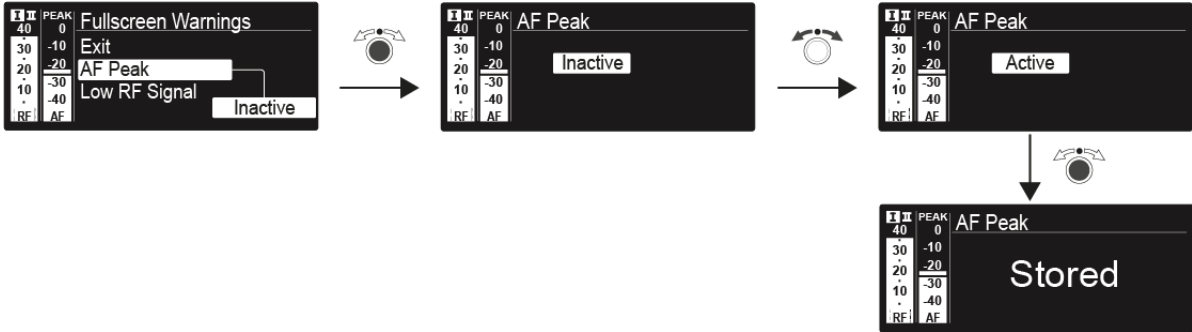

You can activate or deactivate the following warnings:

#### AF Peak

- The audio level is too high.

#### Low RF Signal

- The RF signal is too weak.

#### RF Mute

- The RF signal from the transmitter to the receiver is deactivated.

#### TX Mute

- The transmitter audio signal is muted.

#### RX Mute

- The receiver audio output is muted.

#### Low battery

- The battery charge of the transmitter is low.

### Advanced -> Brightness menu item

In the **Brightness** menu item of the **Advanced** submenu, you can adjust the display contrast of the display panel.

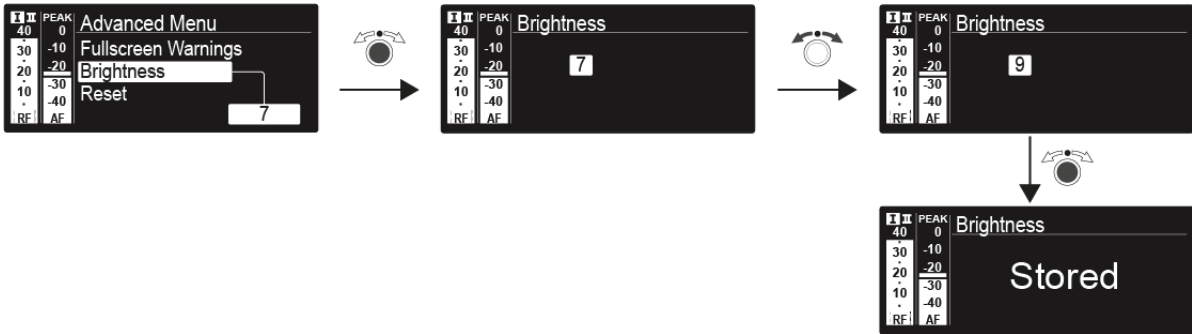



### Advanced -> Reset menu item

In the **Reset** menu item of the **Advanced** submenu, you can reset the settings of the receiver.

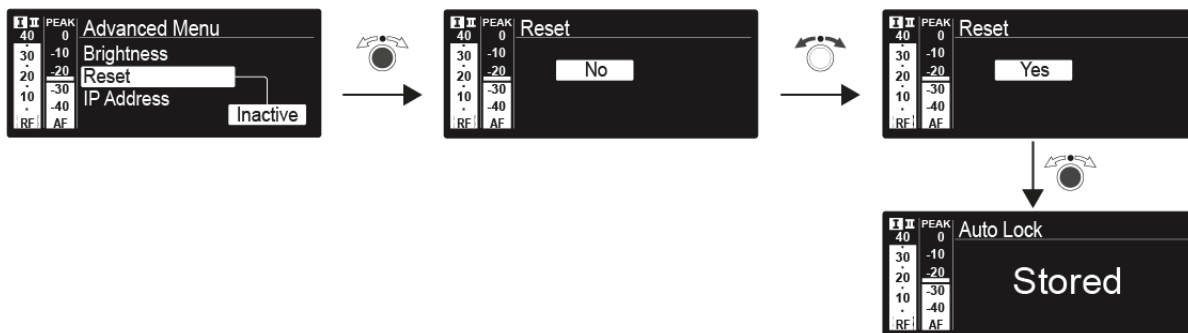

### Advanced -> IP Address menu item

In the **IP Address** menu item of the **Advanced** submenu, you can configure the IP addresses.

The IP addresses can be obtained automatically (automatic) or entered manually (manual).

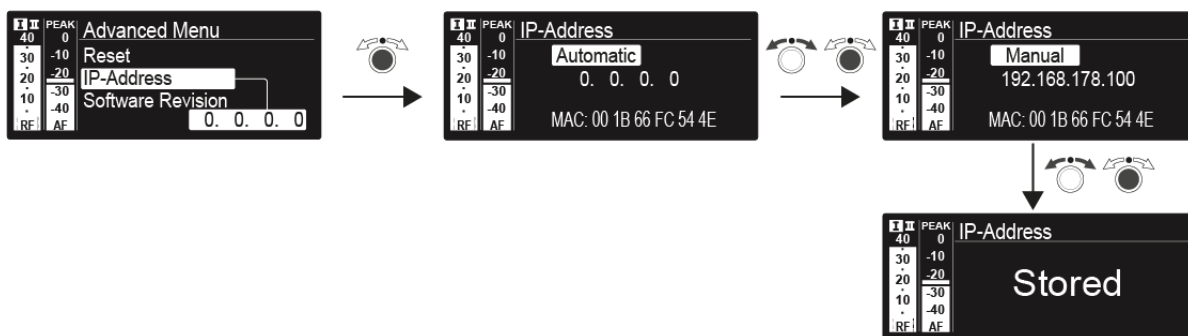

### Advanced -> Software Revision menu item

In the **Software Revision** menu item of the **Advanced** submenu, you can display the current software version of the receiver.