

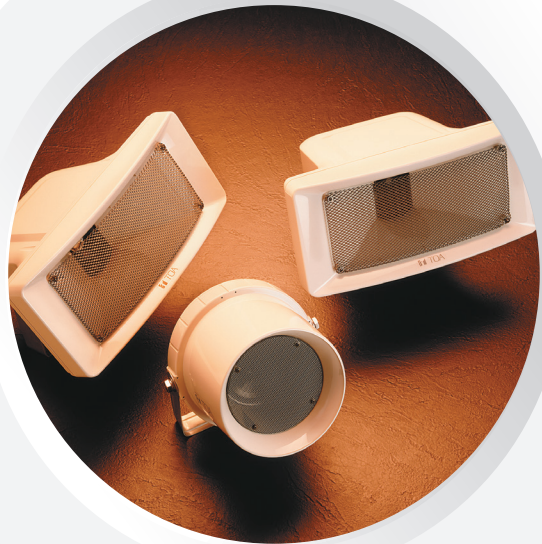

CS Series

Wide Range Speaker



TOA CS SERIES WIDE-RANGE PAGING SPEAKERS are ideal for indoor and outdoor commercial sound system applications for voice paging, background music and tone signaling distribution. CS Series speakers offer wider frequency range and superior sound quality.

Each includes a built-in 70V/100V transformer with screwdriver-adjustable power taps. All CS models are fully weather-resistant to withstand demanding environmental conditions with a sealed enclosure, full-range moisture-resistant cone speaker, stainless-steel mounting hardware and a protective punched net. The enclosure is also coated with polyurethane resin paint to resist the fading effects of prolonged exposure to ultraviolet light.

CS-64

FEATURES

- Wide-range paging speaker for voice paging, background music and tone signaling distribution
- Exponential horn improves directivity characteristics and ensure uniform and clear sound dispersion
- Weatherproof polyurethane resin paint permits the speaker to withstand demanding environmental conditions*
- Lightweight ABS resin enclosure that is mechanically strong and resistant to impact
- Stainless steel hardware protects the speaker from corrosion
- Stainless steel mounting bracket for easy installation and aiming in wall, pole or ceiling-mount applications
- Ideal for schools, parking facilities, boats, industrial, parks, swimming pools, and so on

* Do not install the speaker face-up from a horizontal plane. Be sure to direct the speaker down towards the ground. Otherwise, rain floods the speaker, causing its failure.

APPEARANCE



SPECIFICATIONS

CS-64	
Rated Input	6 W
Rated Impedance	100V line: 1.7kΩ (6W), 3.3kΩ (3W), 10kΩ (1W) 70V line: 830kΩ (6W), 1.7kΩ (3W), 3.3kΩ (1W), 10kΩ (0.5W)
Sensitivity (1W, 1m)	96 dB
Frequency Response	130 Hz - 13k Hz
Speaker Component	12cm (4.72") cone-type (treated for splash proof)
Speaker Code	2 - core cabtype cord with diameter of 6 mm
Operating Temperature	-20°C to +55°C (-4° F to 131° F)
Finish	Horn, cover : ABS resin, off-white, paint Bracket : Stainless steel Punched net : Surface treated steel plate, dark-gray, powder coating Screw: Stainless steel
Dimensions	233 (W) × 224 (H) × 208 (D) mm (9.17" × 8.82" × 8.19")
Weight	1.5kg (3.31 lb)

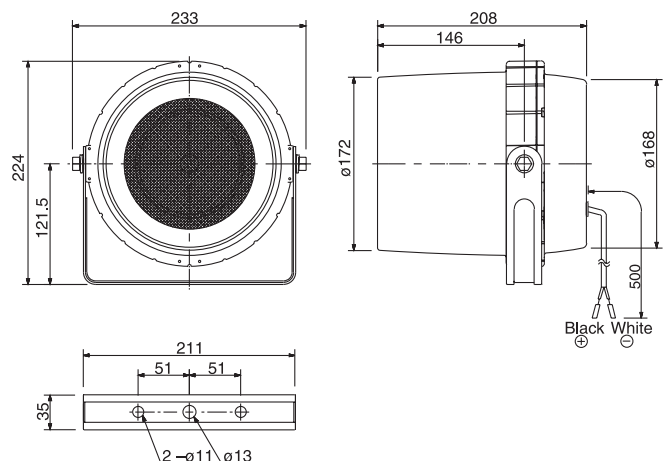

CS-154 , CS-304

FEATURES

- Wide-range paging speaker for voice paging, background music and tone signaling distribution
- Constant directivity horn improves directivity characteristics and ensure uniform and clear sound dispersion
- Weatherproof polyurethane resin paint permits the speaker to withstand demanding environmental conditions*
- IP65 standard compliant
- Lightweight ABS resin enclosure that is mechanically strong and resistant to impact
- Stainless steel hardware protects the speaker from corrosion.
- Stainless steel mounting bracket for easy installation and aiming in wall, pole or ceiling-mount applications
- Ideal for schools, parking facilities, boats, industrial, parks, swimming pools, and so on

*Do not install the speaker face-up from a horizontal plane. Be sure to direct the speaker down towards the ground. Otherwise, rain floods the speaker, causing its failure.



APPEARANCE

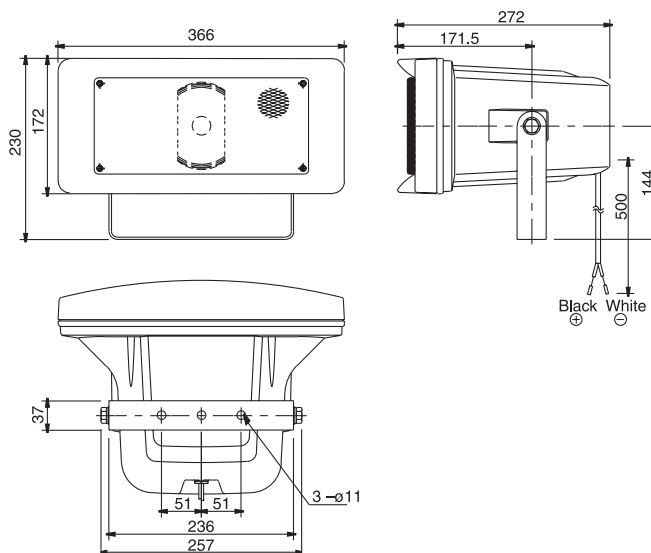

SPECIFICATIONS

CS-154	
Rated Input	15 W
Rated Impedance	100V line: 670Ω (15W), 1kΩ (10W), 2kΩ (5W) 70V line: 330Ω (15W), 670Ω (10W), 1kΩ (5W), 2kΩ (2.5W)
Sensitivity (1W, 1m)	97 dB
Frequency Response	150 Hz - 15k Hz
Speaker Component	12cm (4.72") cone-type (treated for splash proof)
Horizontal Directivity	Constant directivity horn 90° (± 45° horizontal from front axis) / Over 93 dB (1W, 1m), 3k Hz at ± 45°
Speaker Code	2-core cabtyre cord with diameter of 6mm (0.24")
Operating Temperature	-20°C to +55°C (-4°F to 131°F)
Finish	Horn, cover : ABS resin, off-white, paint Bracket : Stainless steel Punched net : Surface treated steel plate, dark-gray, powder coating Screw: Stainless steel
Dimensions	366 (W) × 230 (H) × 272 (D) mm (14.40" × 9.06" × 10.71")
Weight	2.8kg (6.17 lb)

CS-304	
Rated Input	30 W
Rated Impedance	100V line: 330Ω (30W), 500Ω (20W), 1kΩ (10W) 70V line: 170Ω (30W), 330Ω (15W), 500Ω (10W), 2kΩ (5W)
Sensitivity (1W, 1m)	98 dB
Frequency Response	120 Hz - 15k Hz
Speaker Component	12cm (4.72") cone-type (treated for splash proof)
Horizontal Directivity	Constant directivity horn 90° (± 45° horizontal from front axis) / Over 93 dB (1W, 1m), 3k Hz at ± 45°
Speaker Code	2-core cabtyre cord with diameter of 6mm (0.24")
Operating Temperature	-20°C to +55°C (-4°F to 131°F)
Finish	Horn, cover : ABS resin, off-white, paint Bracket : Stainless steel Punched net : Surface treated steel plate, dark-gray, powder coating Screw: Stainless steel
Dimensions	366 (W) × 230 (H) × 272 (D) mm (14.40" × 9.06" × 10.71")
Weight	3.1kg (6.83 lb)

CS-64

Frequency Response(1W/1m:1/3 Octave Pink Noise)

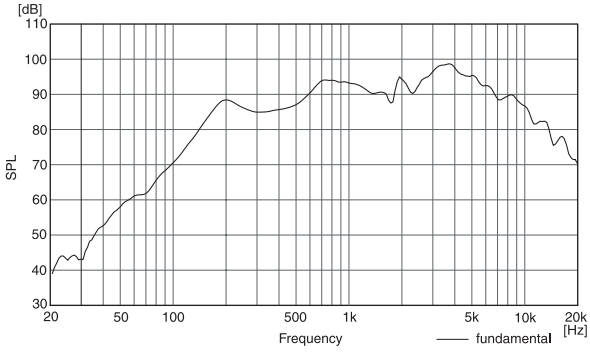

Beamwidth vs. Frequency

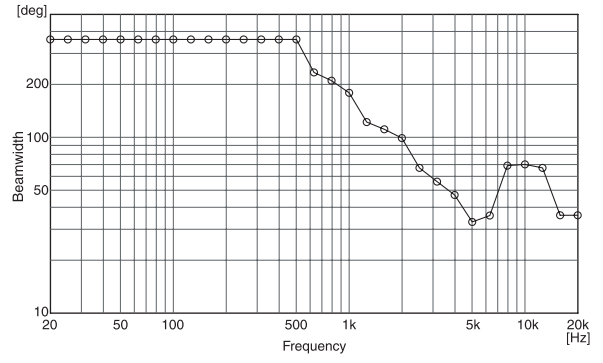

Directivity Factor vs. Frequency

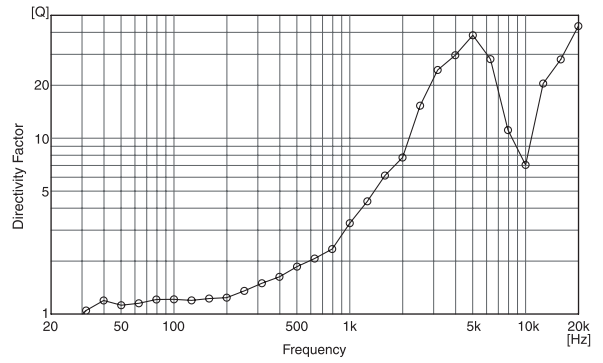

Polar Response

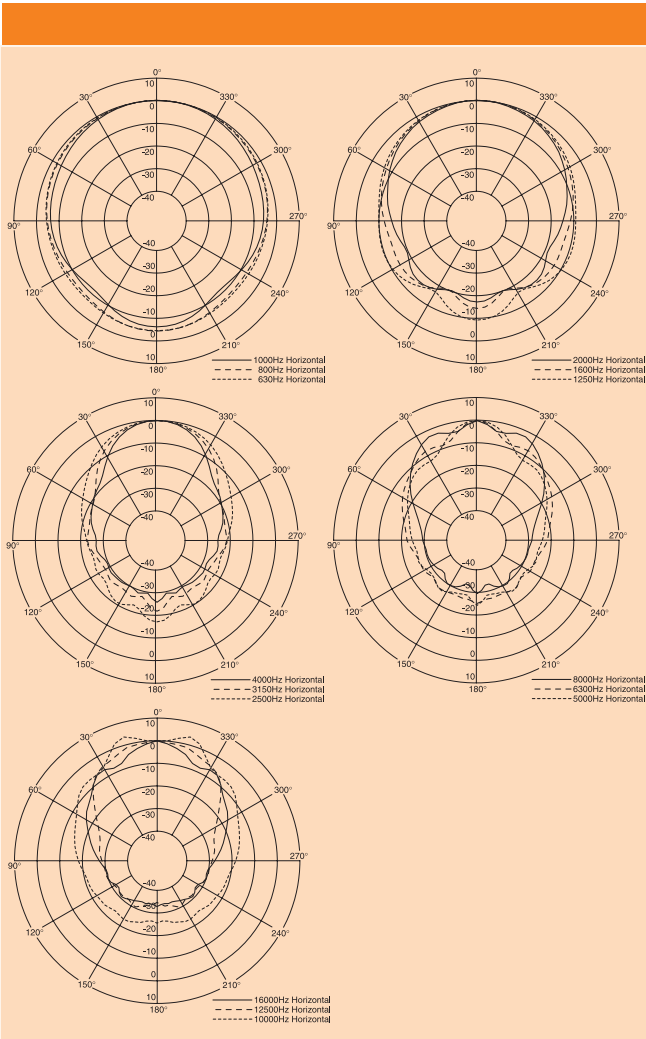

CS-154

Frequency Response(1W/1m:1/3 Octave Pink Noise)

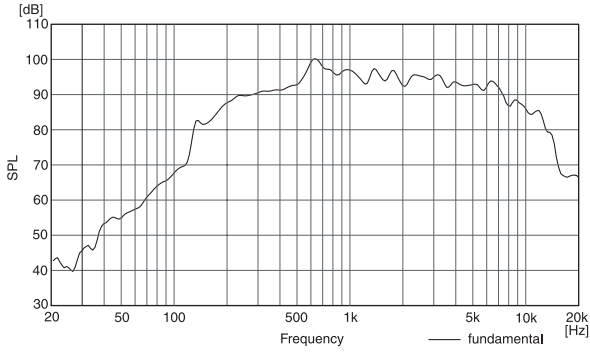

Beamwidth vs. Frequency

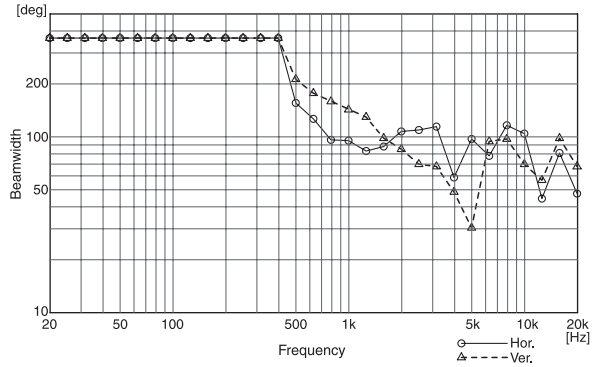

Directivity Factor vs. Frequency

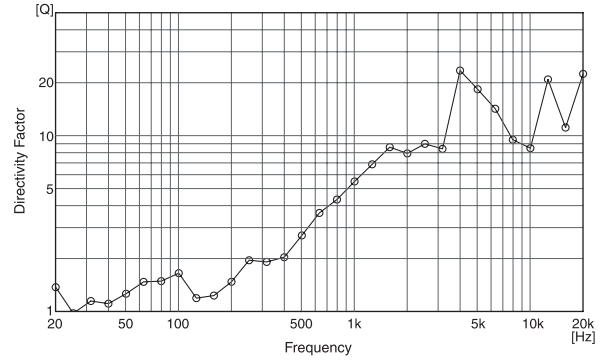

Polar Response

HORIZONTAL

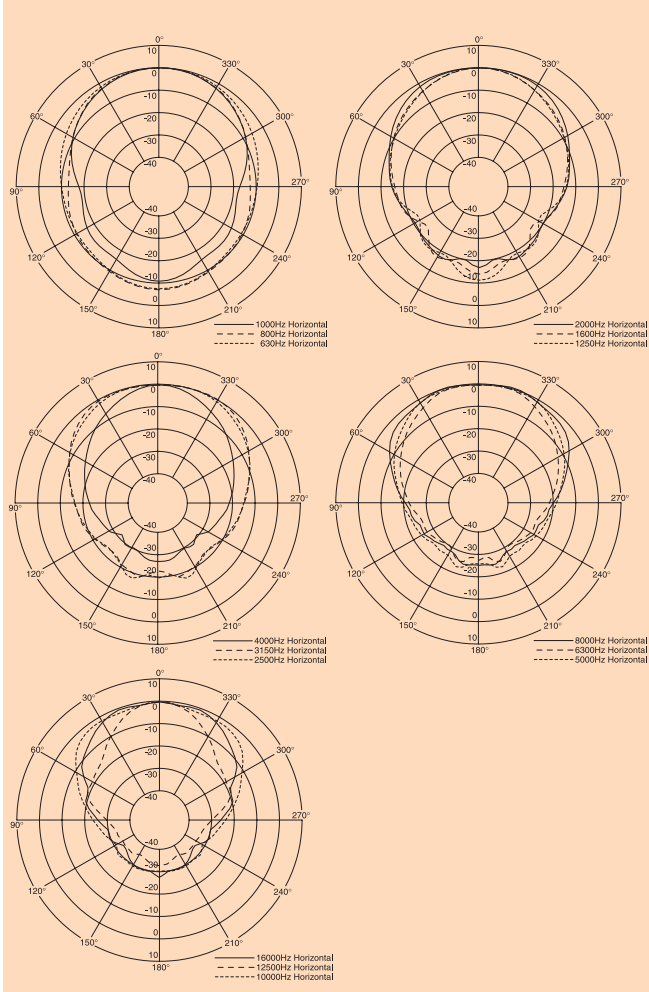

VERTICAL

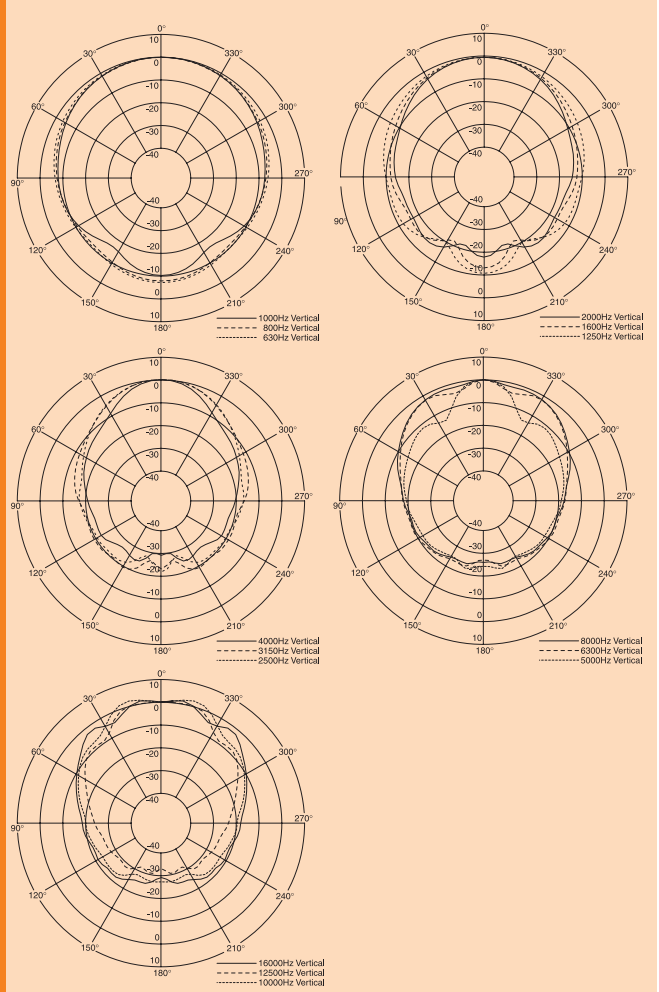

CS-304

Frequency Response(1W/1m:1/3 Octave Pink Noise)

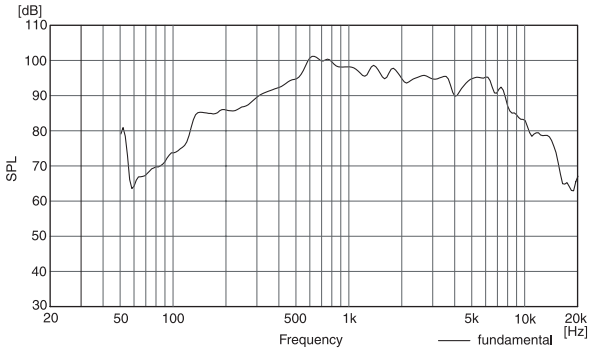

Beamwidth vs. Frequency

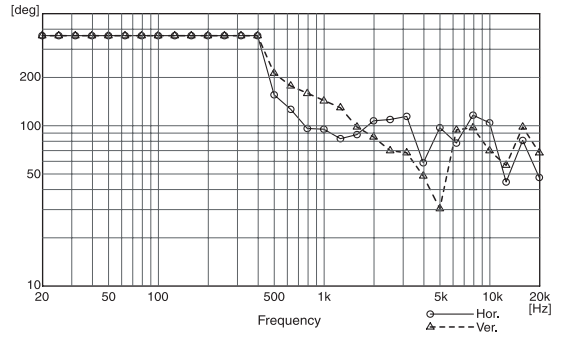

Directivity Factor vs. Frequency

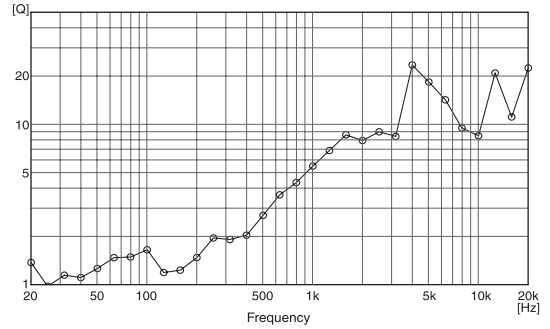

Polar Response

HORIZONTAL

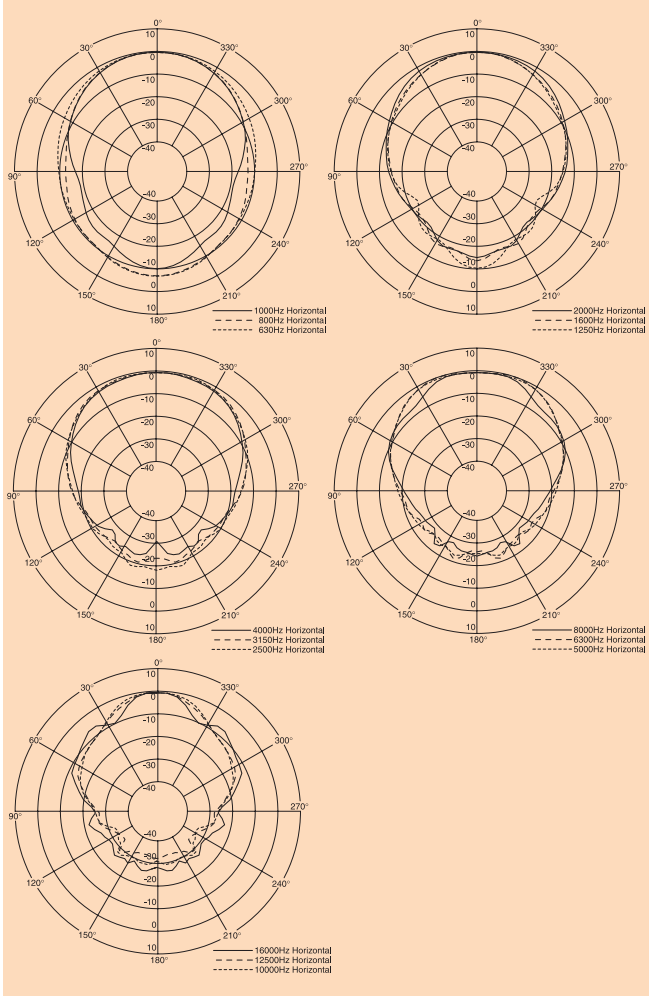

VERTICAL

