

PL 50EN

CEILING SPEAKER WITH FIRE DOME

DESCRIPTION

PL 50EN is a ceiling speaker featuring a flameproof steel back can, designed for recess installation into ceilings or panels. It is especially suitable for broadcasting alarm messages thanks to the highly intelligible sound reproduction and its resistance to high temperatures reached during fires. The terminal connection blocks, for input and output flameproof cables, are made of ceramic material. A thermal fuse protects the integrity of the line in case of heat affecting the speaker. Ground screw available (if needed). Cables inside speaker made using flameproof leads.

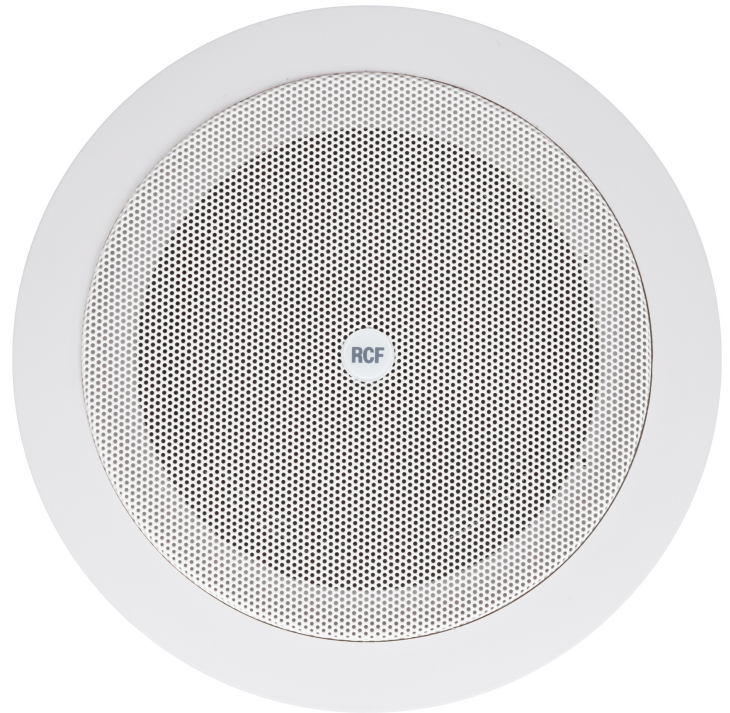

FEATURES

- 5" fullrange transducer.
- Power selectable (100 V): 6 W – 3 W – 1.5 W – 0.75 W.
- 92 dB sensitivity.
- Colour white RAL 9016.
- Steel frame, grille and back can.
- In/out ceramic terminal block.
- Thermal fuse protection.

TECHNICAL SPECIFICATIONS

Acoustical specifications	Frequency Response (-10dB):	130 Hz ÷ 15000 Hz
	Max SPL @ 1m:	100 dB
	Max SPL @ 4m:	88 dB
	Coverage angle:	160°
	System Sensitivity:	92 dB
	System Sensitivity 1W @ 4m:	80 dB
Power section	Power Handling:	6 W
	Peak Power Handling:	24 W PEAK
	Recommended Amplifier:	12 W
	Protections:	Thermal fuse
Transducers	Fullrange:	5.0"
Input/Output section	Input connectors:	Ceramic screw terminals
	Output connectors:	Ceramic screw terminals
	Constant Voltage Transformer:	100 V
	Power selection 1:	6 W - 1667 ohm
	Power selection 2:	3 W - 3333 ohm
	Power selection 3:	1.5 W - 6667 ohm
Power selection 4:	0.75 W - 13333 ohm	
Standard compliance	EN54-24 certified:	Yes
	CE marking:	Yes
	CPR number:	0068-CPR-051/2017
Physical specifications	Cabinet/Case Material:	Metal
	Hardware:	Steel back cover
	Grille:	Steel
	Color:	White - RAL 9016
Size	Depth:	143 mm / 5.63 inches
	Recessed Depth:	125 mm / 4.92 inches
	Diameter:	181 mm / 7.13 inches
	Cut out diameter:	155 mm / 6.1 inches
	Weight:	1.35 kg / 2.98 lbs
Shipping informations	Package Height:	160 mm / 6.3 inches
	Package Width:	190 mm / 7.48 inches
	Package Depth:	190 mm / 7.48 inches
	Package Weight:	1.35 kg / 2.98 lbs



PART NUMBER

- **13100007**

PL 50EN

EAN 8024530014384

DRAWINGS

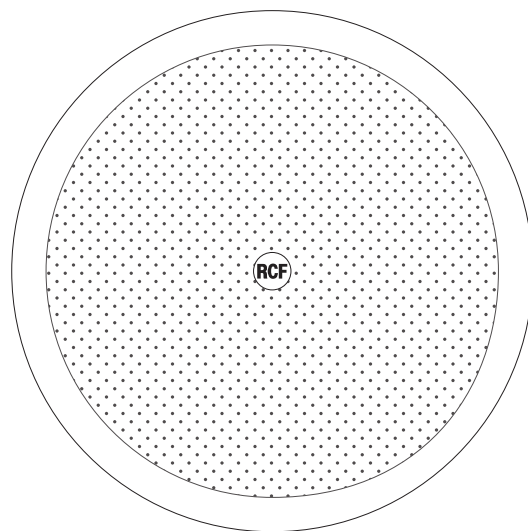
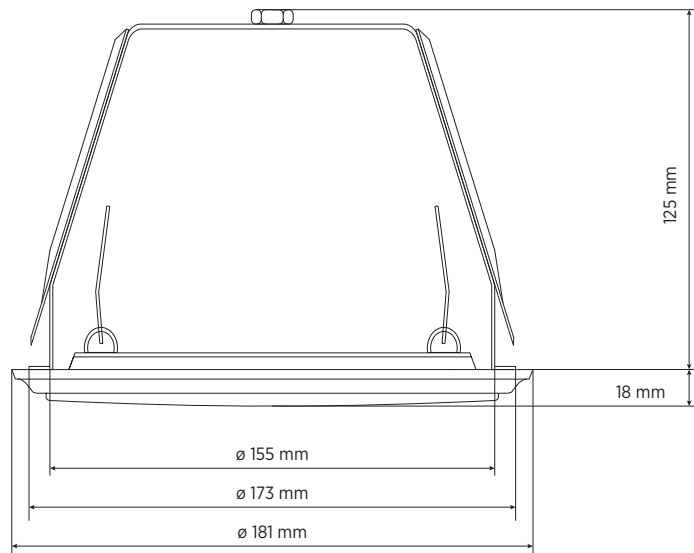

SCHEMATICS

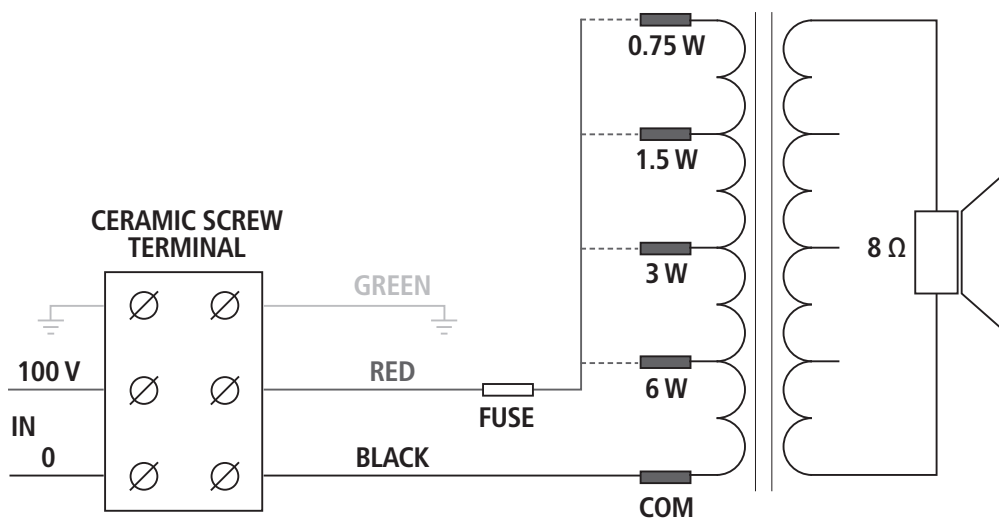

TAP (pins)	POWER (100 V)	POWER (70 V)
1	0.75 W	0.375 W
2	1.5 W	0.75 W
3	3 W	1.5 W
4	6 W	3 W

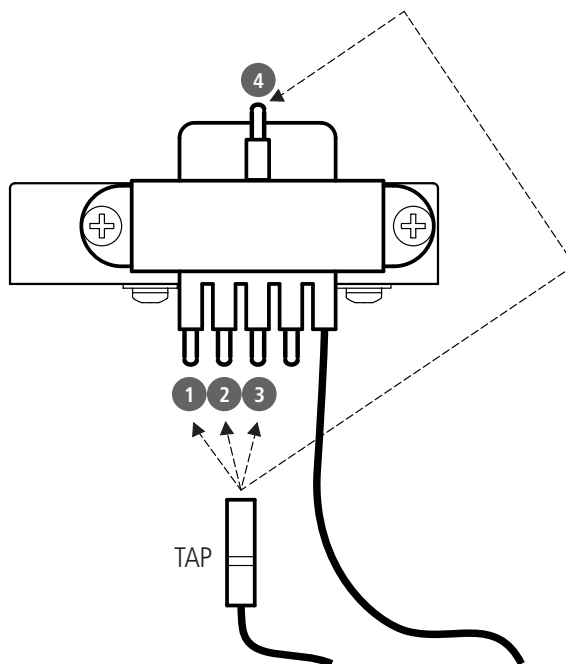

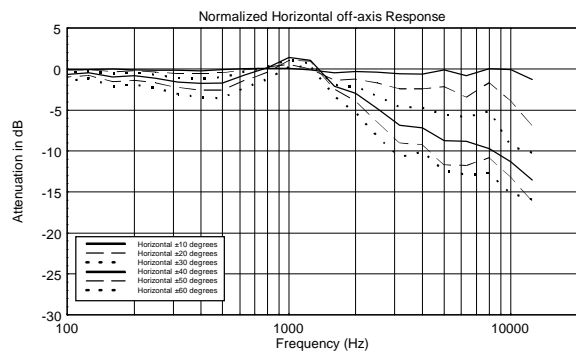
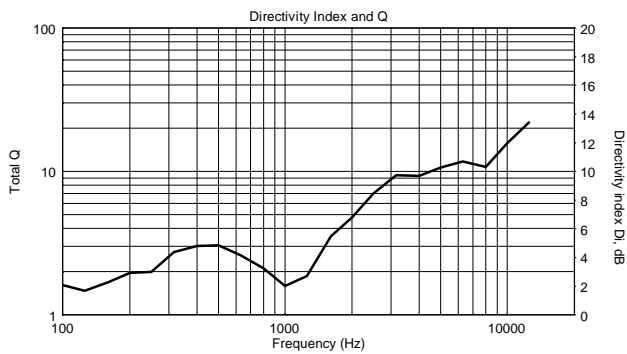
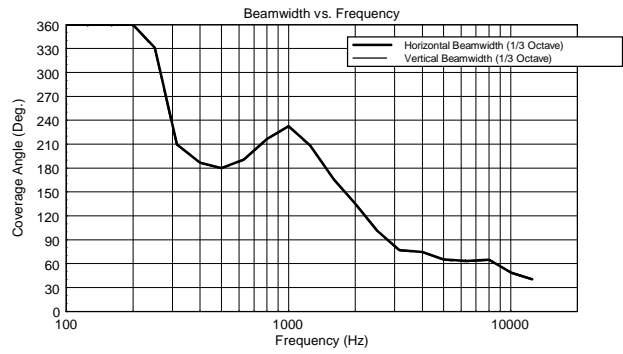
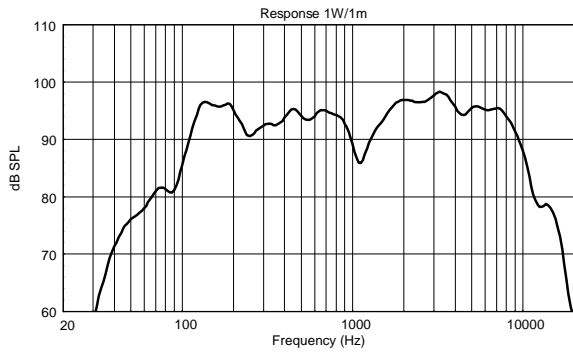

Horizontal 1/3 Octave Polars

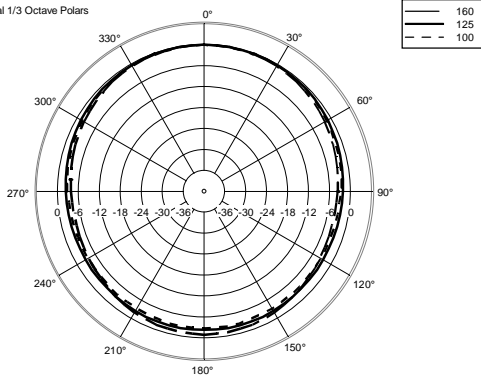

Horizontal 1/3 Octave Polars

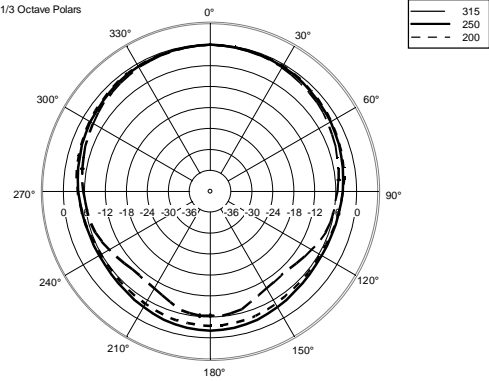

Horizontal 1/3 Octave Polars

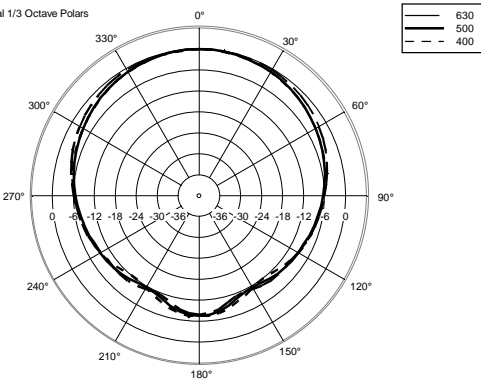

Horizontal 1/3 Octave Polars

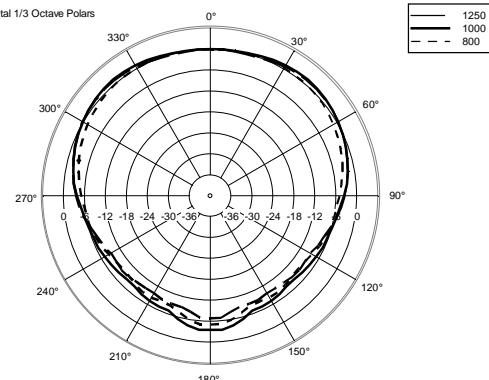

Horizontal 1/3 Octave Polars

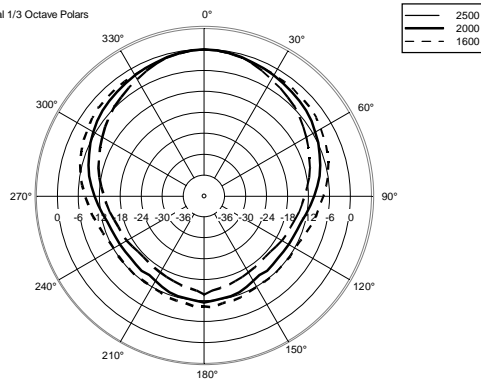

Horizontal 1/3 Octave Polars

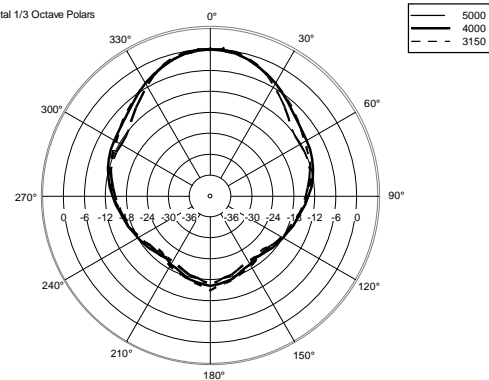

Horizontal 1/3 Octave Polars

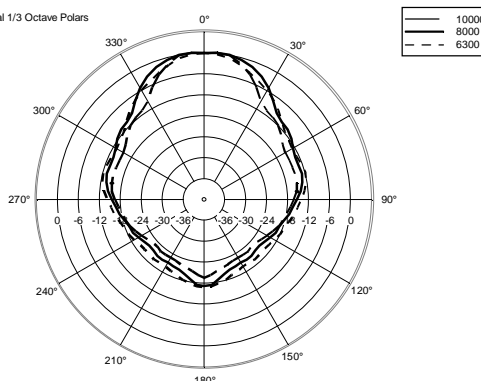

Horizontal One Octave Polars

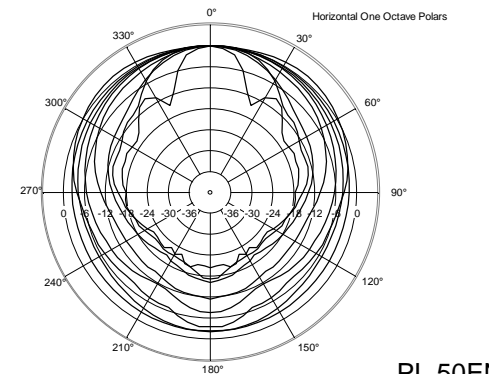



ACCESSORIES



A&E SPECIFICATIONS

The product shall be a ceiling speaker having a flameproof steel backcan, designed for recess installation into ceilings or panels and especially suitable for broadcasting background music into commercial spaces, but also alarm messages thanks to the highly intelligible voice reproduction and the EN 54-24 certification.

It shall feature a metal case with steel grille.

The terminal connection blocks, for input and output flameproof cables, shall be made of ceramic material. A thermal fuse shall protect the line integrity in case of heat affecting the speaker.

NOTES

NO CAUTION is NECESSARY in case of ALERTED PERSON for AUDIO voltages up to 120V, when warning symbols are present near the connection terminals. In the case of AUDIO voltages up to 71V, it is not even necessary to put warning symbols.

No need of linking to earth metal parts of speakers equipped with transformers and connected to 70.7 V / 100 V outputs of power amplifiers that do not have any reference to earth (ref. EN 62368-1 item 4.3.2.2), unless specific local requirements.
